

FCC Information and Copyright

This equipment has been tested and found to comply with the limits of a Class B digital device, pursuant to Part 15 of the FCC Rules. These limits are designed to provide reasonable protection against harmful interference in a residential installation. This equipment generates, uses, and can radiate radio frequency energy and, if not installed and used in accordance with the instructions, may cause harmful interference to radio communications. There is no guarantee that interference will not occur in a particular installation.

The vendor makes no representations or warranties with respect to the contents here and specially disclaims any implied warranties of merchantability or fitness for any purpose. Further the vendor reserves the right to revise this publication and to make changes to the contents here without obligation to notify any party beforehand.

Duplication of this publication, in part or in whole, is not allowed without first obtaining the vendor's approval in writing.

The content of this user's manual is subject to be changed without notice and we will not be responsible for any mistakes found in this user's manual. All the brand and product names are trademarks of their respective companies.



Dichiarazione di conformità sintetica

Ai sensi dell'art. 2 comma 3 del D.M. 275 del 30/10/2002

Si dichiara che questo prodotto è conforme alle normative vigenti e soddisfa i requisiti essenziali richiesti dalle direttive

2004/108/CE, 2006/95/CE e 1999/05/CE

quando ad esso applicabili

Short Declaration of conformity

We declare this product is complying with the laws in force and meeting all the essential requirements as specified by the directives

2004/108/CE, 2006/95/CE and 1999/05/CE

whenever these laws may be applied

Table of Contents

Chapter 1: Introduction	1
1.1 Before You Start.....	1
1.2 Package Checklist.....	1
1.3 Motherboard Specifications	2
1.4 Rear Panel Connectors	4
1.5 Motherboard Layout	5
Chapter 2: Hardware Installation	6
2.1 Install Central Processing Unit (CPU)	6
2.2 Install a Heatsink	7
2.3 Connect Cooling Fans	8
2.4 Install System Memory	9
2.5 Expansion Slots	11
2.6 Jumper Setting	12
2.7 Headers & Connectors	13
Chapter 3: UEFI BIOS & Software	19
3.1 UEFI BIOS Setup	19
3.2 BIOS Update	19
3.3 Software.....	24
Chapter 4: Useful Help	27
4.1 Driver Installation.....	27
4.2 AMI BIOS Beep Code.....	28
4.3 Troubleshooting	28
4.4 RAID Functions	30
4.5 AMD Dual Graphics Technology	34
Appendix: Specifications In Other Languages	36
Arabic	36
French	38
German.....	40
Italian	42
Japanese.....	44
Polish.....	46
Portuguese	48
Russian.....	50
Spanish.....	52

CHAPTER 1: INTRODUCTION

1.1 Before You Start

Thank you for choosing our product. Before you start installing the motherboard, please make sure you follow the instructions below:

- Prepare a dry and stable working environment with sufficient lighting.
- Always disconnect the computer from power outlet before operation.
- Before you take the motherboard out from anti-static bag, ground yourself properly by touching any safely grounded appliance, or use grounded wrist strap to remove the static charge.
- Avoid touching the components on motherboard or the rear side of the board unless necessary. Hold the board on the edge, do not try to bend or flex the board.
- Do not leave any unfastened small parts inside the case after installation. Loose parts will cause short circuits which may damage the equipment.
- Keep the computer from dangerous area, such as heat source, humid air and water.
- The operating temperatures of the computer should be 0 to 45 degrees Celsius.
- To avoid injury, be careful of:
 - Sharp pins on headers and connectors
 - Rough edges and sharp corners on the chassis
 - Damage to wires that could cause a short circuit

1.2 Package Checklist

- Serial ATA Cable x2
- Rear I/O Panel for ATX Case x1
- User's Manual x1
- Fully Setup Driver DVD x1

<p>Note: The package contents may be different due to the sales region or models in which it was sold. For more information about the standard package in your region, please contact your dealer or sales representative.</p>

1.3 Motherboard Specifications

Specifications			
CPU Support	Socket FM2 for AMD A-series processor Maximum CPU TDP (Thermal Design Power): 100Watt * Please refer to www.biostar.com.tw for CPU support list.		
Chipset	AMD A85 FCH (Hi-Fi A85S2) AMD A75 FCH (Hi-Fi A75S2) AMD A55 FCH (Hi-Fi A55S2)		
Memory	Supports Dual Channel DDR3 800/ 1066/ 1333/ 1600/ 1866 2 x DDR3 DIMM Memory Slot, Max. Supports up to 32 GB Memory Each DIMM supports non-ECC 512MB/ 1/ 2/ 4/ 8/ 16 GB DDR3 module * Please refer to www.biostar.com.tw for Memory support list.		
Storage	AMD A85/A75/A55 FCH Supports RAID 0,1,10, 5 & AHCI (AMD A85 FCH) Supports RAID 0,1,10, & AHCI (AMD A75/A55 FCH),		
LAN	Realtek RTL 8111F 10/ 100/ 1000 Mb/s auto negotiation, Half / Full duplex capability		
Audio Codec	ALC892 5.1 Channels, High Definition Audio, Biostar Hi-Fi		
USB	AMD A85/A75 FCH: 6x USB 2.0 port (2 on rear I/Os and 4 via internal headers) 4x USB 3.0 port (2 on rear I/Os and 2 via internal headers) AMD A55 FCH: 8x USB 2.0 port (4 on rear I/Os and 4 via internal headers)		
Expansion Slots	3x PCI Slot 2x PCIe 2.0 x1 Slot 1x PCIe 2.0 x16 Slot		
Rear I/Os	Hi-Fi A85S2: 1x PS/2 Mouse 1x PS/2 Keyboard 1x HDMI Port 1x VGA Port 1x DVI Port 1x LAN port 2x USB 2.0 Port 2x USB 3.0 Port 3x Audio Jack	Hi-Fi A75S2: 1x PS/2 Mouse 1x PS/2 Keyboard 1x HDMI Port 1x VGA Port 1x DVI Port 1x LAN port 2x USB 2.0 Port 2x USB 3.0 Port 3x Audio Jack	Hi-Fi A55S2: 1x PS/2 Mouse 1x PS/2 Keyboard 1x VGA Port 1x DVI Port 1x LAN port 4x USB 2.0 Port 3x Audio Jack

Hi-Fi A85S2/Hi-Fi A75S2/Hi-Fi A55S2

Specifications			
	Hi-Fi A85S2:	Hi-Fi A75S2:	Hi-Fi A55S2:
Internal I/Os	8x SATA 6.0Gb/s Connector	6x SATA 6.0Gb/s Connector	6x SATA 3.0Gb/s Connector
	2x USB 2.0 Header	2x USB 2.0 Header	2x USB 2.0 Header
	1x USB 3.0 Header	1x USB 3.0 Header	1x 4-Pin Power Connector
	1x 4-Pin Power Connector	1x 4-Pin Power Connector	1x 24-Pin Power Connector
	1x 24-Pin Power Connector	1x 24-Pin Power Connector	1x CPU Fan Connector
	1x CPU Fan Connector	1x CPU Fan Connector	2x System Fan Connector
	2x System Fan Connector	2x System Fan Connector	1x Front Panel Header
	1x Front Panel Header	1x Front Panel Header	1x Front Audio Header
	1x Front Audio Header	1x Front Audio Header	1x Clear CMOS Header
	1x Clear CMOS Header	1x Clear CMOS Header	1x Printer Port Header
	1x Printer Port Header	1x Printer Port Header	1x Consumer IR Header
	1x Consumer IR Header	1x Consumer IR Header	1x Serial Port Header
	1x Serial Port Header	1x Serial Port Header	1x S/PDIF out Connector
	1x S/PDIF out Connector	1x S/PDIF out Connector	
Form Factor	ATX Form Factor, 295 mm x 200 mm		
OS Support	Windows XP / Vista / 7 / 8 Biostar reserves the right to add or remove support for any OS with or without notice.		

1.4 Rear Panel Connectors

Hi-Fi A85S2 / Hi-Fi A75S2

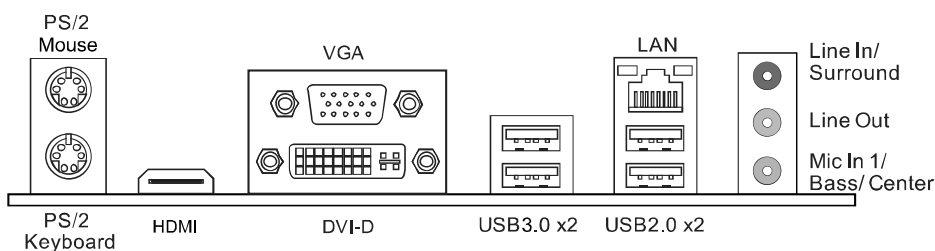

Hi-Fi A55S2

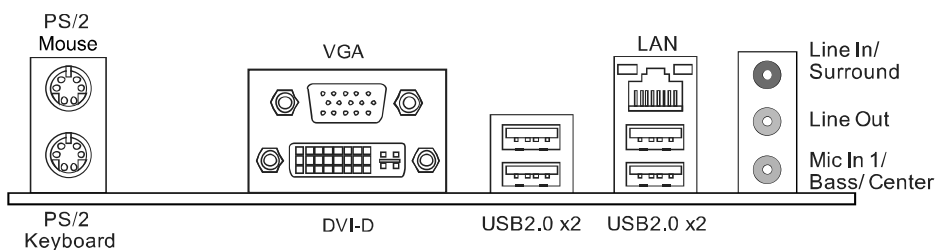

- Note 1:** HDMI / DVI-D / VGA Output require an AMD family processor with integrated graphics.
- Note 2:** The mainboard supports three independent display outputs except Hi-Fi A55S2.
- Note 3:** Since the audio chip supports High Definition Audio Specification, the function of each audio jack can be defined by software. The input / output function of each audio jack listed above represents the default setting. However, when connecting external microphone to the audio port, please use the Line In (Blue) and Mic In (Pink) audio jack.
- Note 4:** Maximum resolution:

Outputs	Maximum resolution	Bit Depth
HDMI	1920 x 1080 @60Hz	24, 30, 36 bpp
	1920 x 1200 @60Hz	24 bpp
DVI-D	1920 x 1200 @60Hz	30 bpp
	2560 x 1600 @60Hz	24 bpp
VGA	1920 x 1600 @60Hz	--

1.5 Motherboard Layout

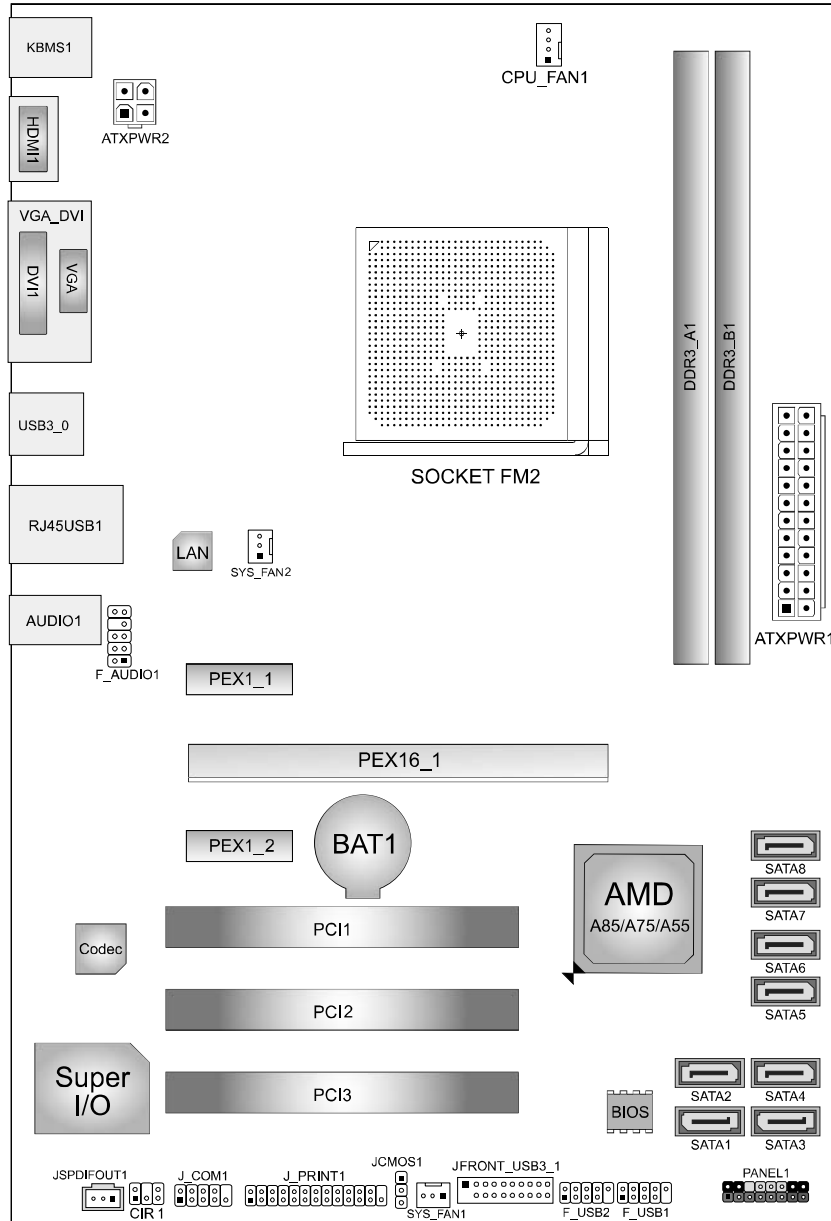

Note1: ■ represents the 1st pin.
Note2: SATA7 & SATA8 are only for Hi-Fi A85S2.

CHAPTER 2: HARDWARE INSTALLATION

2.1 Install Central Processing Unit (CPU)

Step 1: Locate the CPU socket on the motherboard

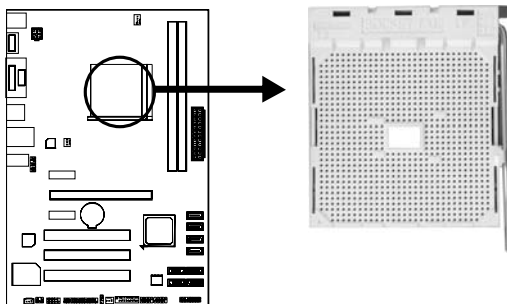

Step 2: Pull the socket locking out from the socket and then raise the lever up to a 90-degree angle.

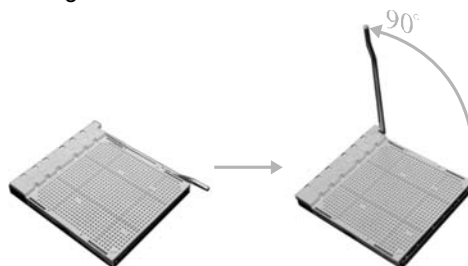

Step 3: Look for the white triangle on socket, and the gold triangle on CPU should point towards this white triangle. The CPU will fit only in the correct orientation.



Note: The CPU fits only in one correct orientation. Do not force the CPU into the socket to prevent damaging the CPU.

Step 4: Hold the CPU down firmly, and then close the lever to locked the position

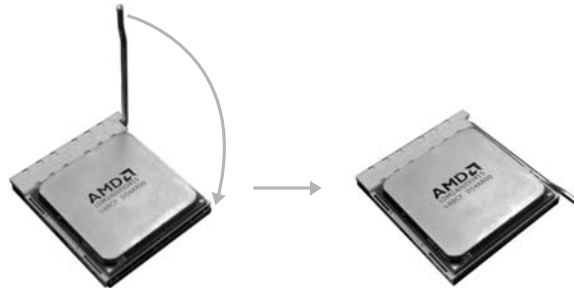

2.2 Install a Heatsink

Step 1: Place the heatsink and fan assembly onto the retention frame. Match the heatsink clip with the socket mounting-lug. Hook the spring clip to the mounting-lug.

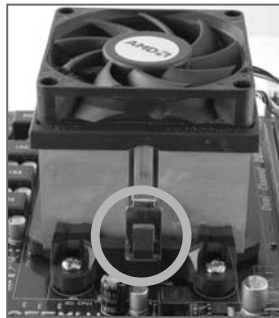

Step 2: On the other side, push the retention clip straight down to lock into the plastic lug on the retention frame, and then press down the locker until it stops.



Note1: Do not forget to connect the CPU fan connector.
Note2: For proper installation, please kindly refer to the installation manual of your CPU heatsink.

2.3 Connect Cooling Fans

These fan headers support cooling-fans built in the computer. The fan cable and connector may be different according to the fan manufacturer. Connect the fan cable to the connector while matching the black wire to pin#1.

CPU_FAN1: CPU Fan Header

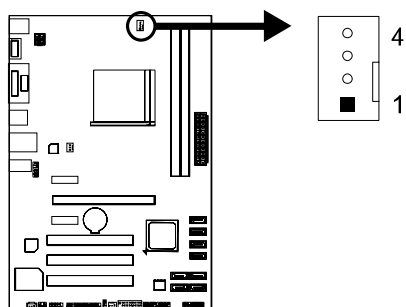

Pin	Assignment
1	Ground
2	+12V
3	FAN RPM rate sense
4	Smart Fan Control (By Fan)

SYS_FAN1/SYS_FAN2: System Fan Header

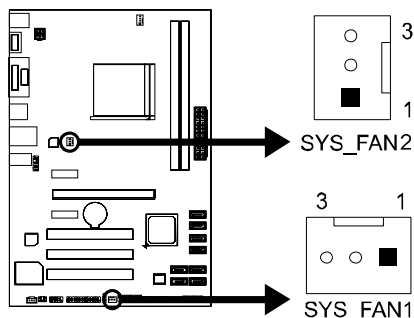

Pin	Assignment
1	Ground
2	+12V
3	FAN RPM rate sense

Note: CPU_FAN1, SYS_FAN1 support 4-pin and 3-pin head connectors. When connecting with wires onto connectors, please note that the red wire is the positive and should be connected to pin#2, and the black wire is Ground and should be connected to GND.

2.4 Install System Memory

A. DDR3 Modules

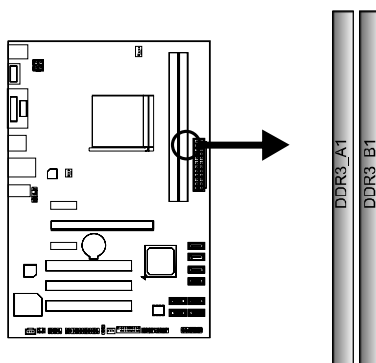

Step 1: Unlock a DIMM slot by pressing the retaining clips outward. Align a DIMM on the slot such that the notch on the DIMM matches the break on the slot.

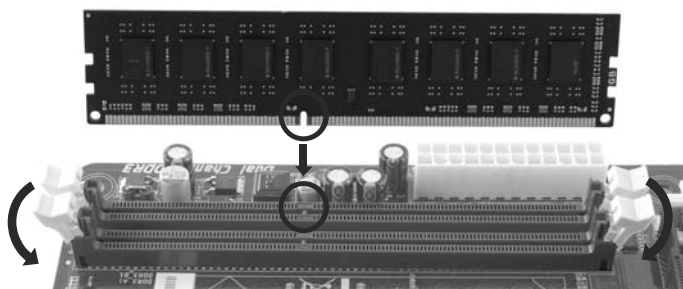

Step 2: Insert the DIMM vertically and firmly into the slot until the retaining chip snap back in place and the DIMM is properly seated.



Note: If the DIMM does not go in smoothly, do not force it. Pull it all the way out and try again.

B. Memory Capacity

DIMM Socket Location	DDR3 Module	Total Memory Size
DDR3_A1	512MB/1GB/2GB/4GB/8GB/16GB	Max is 32GB.
DDR3_B1	512MB/1GB/2GB/4GB/8GB/16GB	

C. Dual Channel Memory Installation

Please refer to the following requirements to activate Dual Channel function:
Install memory module of the same density in pairs, shown in the table.

Dual Channel Status	DDR3_A1	DDR3_B1
Disabled	O	X
Disabled	X	O
Enabled	O	O

(O means memory installed, X means memory not installed.)

Note: The DRAM bus width of the memory module must be the same (x8 or x16)

2.5 Expansion Slots

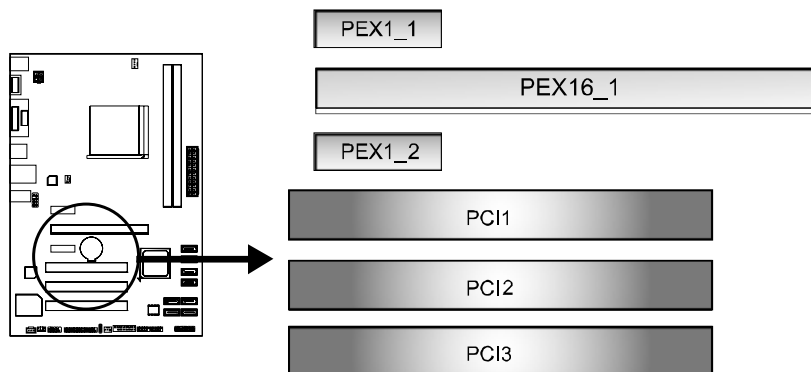

PEX16_1: PCI-Express Gen2 x16 Slot

- PCI-Express 2.0 compliant.
- Maximum theoretical realized bandwidth of 8GB/s simultaneously per direction, for an aggregate of 16GB/s totally.
- PCI-Express Gen2 supports a raw bit-rate of 5.0Gb/s on the data pins.

PEX1_1/PEX1_2: PCI-Express Gen2 x1 Slot

- PCI-Express 2.0 compliant.
- Data transfer bandwidth up to 500MB/s per direction; 1GB/s in total

PCI1/ PCI2/ PCI3: Peripheral Component Interconnect Slot

This motherboard is equipped with 1 standard PCI slot. PCI stands for Peripheral Component Interconnect, and it is a bus standard for expansion cards.

Install an Expansion Card

You can install your expansion card by following steps:

1. Read the related expansion card's instruction document before install the expansion card into the computer.
2. Remove your computer's chassis cover, screws and slot bracket from the computer.
3. Place a card in the expansion slot and press down on the card until it is completely seated in the slot.
4. Secure the card's metal bracket to the chassis back panel with a screw.
5. Replace your computer's chassis cover.
6. Power on the computer, if necessary, change BIOS settings for the expansion card.
7. Install related driver for the expansion card.

2.6 Jumper Setting

The illustration shows how to set up jumpers. When the jumper cap is placed on pins, the jumper is “close”, if not, that means the jumper is “open”.



JCMOS1: Clear CMOS Header

Placing the jumper on pin2-3, it allows user to restore the BIOS safe setting and the CMOS data. Please carefully follow the procedures to avoid damaging the motherboard.

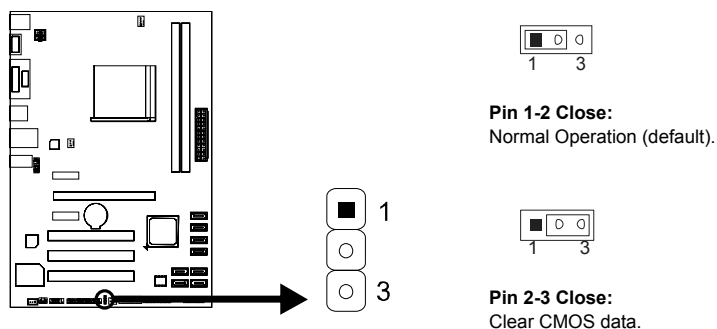

※ Clear CMOS Procedures:

1. Remove AC power line.
2. Set the jumper to “Pin 2-3 close”.
3. Wait for five seconds.
4. Set the jumper to “Pin 1-2 close”.
5. Power on the AC.
6. Load Optimal Defaults and save settings in CMOS.

2.7 Headers & Connectors

ATXPWR1: ATX Power Source Connector

This connector allows user to connect 24-pin power connector on the ATX power supply.

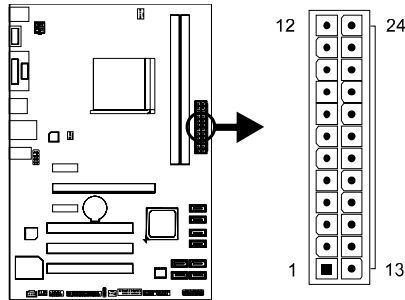

Pin	Assignment	Pin	Assignment
13	+3.3V	1	+3.3V
14	-12V	2	+3.3V
15	Ground	3	Ground
16	PS_ON	4	+5V
17	Ground	5	Ground
18	Ground	6	+5V
19	Ground	7	Ground
20	NC	8	PW_OK
21	+5V	9	Standby Voltage+5V
22	+5V	10	+12V
23	+5V	11	+12V
24	Ground	12	+3.3V

ATXPWR2: ATX Power Source Connector

This connector will provide +12V to CPU power circuit.

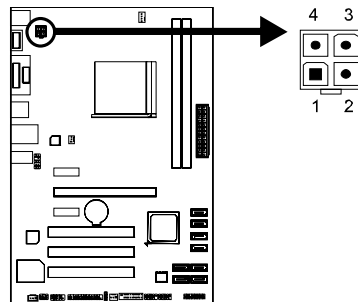

Pin	Assignment
1	+12V
2	+12V
3	Ground
4	Ground

Note1: Before you power on the system, please make sure that both ATXPWR1 and ATXPWR2 connectors have been plugged-in.

Note2: Insufficient power supplied to the system may result in instability or the peripherals not functioning properly. Use of a PSU with a higher power output is recommended when configuring a system with more power-consuming devices.

PANEL1: Front Panel Header

This 16-pin connector includes Power-on, Reset, HDD LED, Power LED, and speaker connection. It allows user to connect the PC case's front panel switch functions.

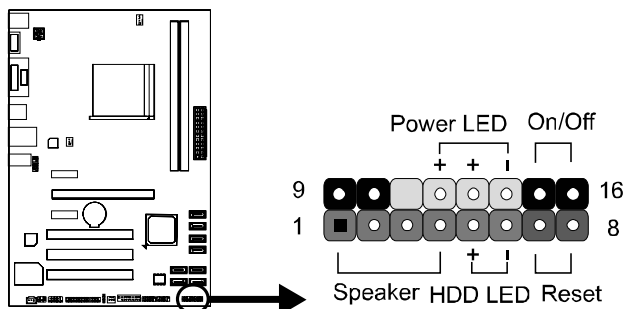

Pin	Assignment	Function	Pin	Assignment	Function
1	+5V	Speaker Connector	9	N/A	N/A
2	N/A		10	N/A	N/A
3	N/A		11	N/A	N/A
4	Speaker		12	Power LED (+)	Power LED
5	HDD LED (+)	13	Power LED (+)		
6	HDD LED (-)	14	Power LED (-)		
7	Ground	Reset button	15	Power button	Power-on button
8	Reset control		16	Ground	

SATA1~SATA8: Serial ATA Connectors

These connectors connect to SATA hard disk drives via SATA cables.

- Hi-Fi A85S2 & Hi-Fi A75S2 satisfy the SATA 3.0 spec and with transfer rate of 6.0Gb/s.
- Hi-Fi A55S2 satisfies the SATA 2.0 spec and with transfer rate of 3.0Gb/s.
- SATA7 & SATA8 are only for Hi-Fi A85S2.

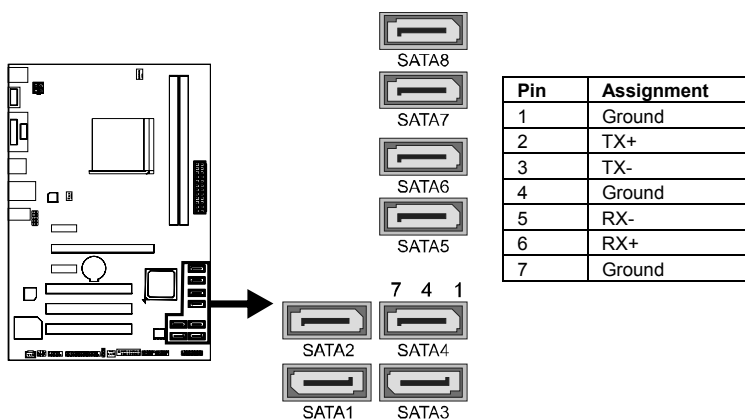

JFRONT_USB3_1: Header for USB 3.0 Ports at Front Panel

This header allows user to connect additional USB cable on the PC front panel, and also can be connected with a wide range of simultaneously accessible external Plug and Play peripherals.

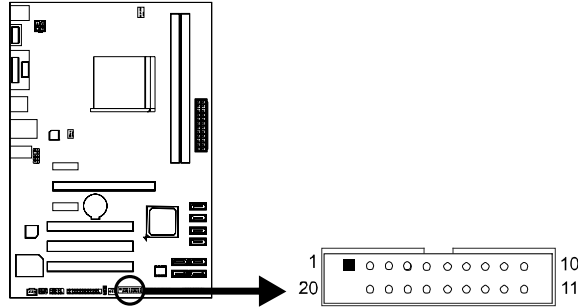

Pin	Assignment	Pin	Assignment
1	VBUS0	11	D2+
2	SSRX1-	12	D2-
3	SSRX1+	13	Ground
4	Ground	14	SSTX2+
5	SSTX1-	15	SSTX2-
6	SSTX1+	16	Ground
7	Ground	17	SSRX2+
8	D1-	18	SSRX2-
9	D1+	19	VBUS1
10	ID	20	Key

Note: The USB 3.0 header is only for Hi-Fi A85S2 and Hi-Fi A75S2

F_USB1/F_USB2: Headers for USB 2.0 Ports at Front Panel

This header allows user to connect additional USB cable on the PC front panel, and also can be connected with a wide range of simultaneously accessible external Plug and Play peripherals.

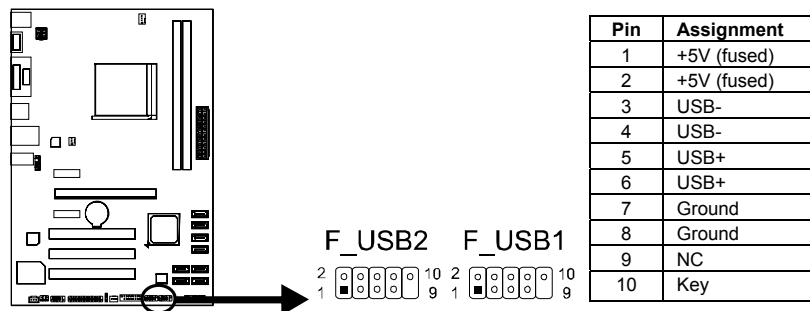

Pin	Assignment
1	+5V (fused)
2	+5V (fused)
3	USB-
4	USB-
5	USB+
6	USB+
7	Ground
8	Ground
9	NC
10	Key

F_AUDIO1: Front Panel Audio Header

This header allows user to connect the front audio output cable with the PC front panel. This header supports HD and AC'97 audio front panel connector.

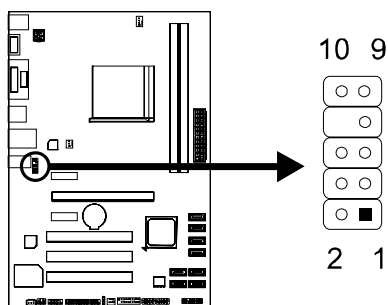

HD Audio		AC'97	
Pin	Assignment	Pin	Assignment
1	Mic Left in	1	Mic In
2	Ground	2	Ground
3	Mic Right in	3	Mic Power
4	GPIO	4	Audio Power
5	Right line in	5	RT Line Out
6	Jack Sense	6	RT Line Out
7	Front Sense	7	Reserved
8	Key	8	Key
9	Left line in	9	LFT Line Out
10	Jack Sense	10	LFT Line Out

Note1: It is recommended that you connect a high-definition front panel audio module to this connector to avail of the motherboard's high definition audio capability.
Note2: Please try to disable the "Front Panel Jack Detection" if you want to use an AC'97 front audio output cable. The function can be found via O.S. Audio Utility.

JSPDIFOUT1: Digital Audio-out Connectors

The JSPDIFOUT1 is for connecting the PCI bracket SPDIF output.

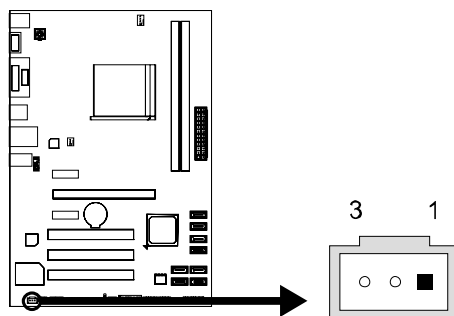

Pin	Assignment
1	+5V
2	SPDIF_OUT
3	Ground

J_COM1: Serial Port Connector

The motherboard has a Serial Port Connector for connecting RS-232 Port.

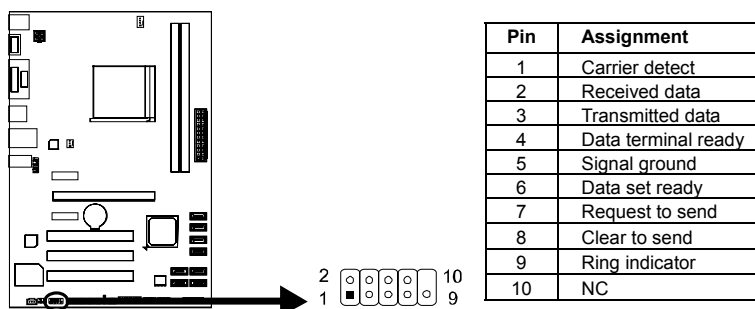

J_PRINT1: Printer Port Connector

This header allows you to connector printer on the PC.

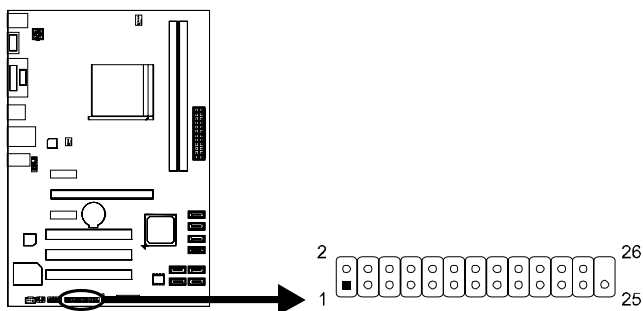

Pin	Assignment	Pin	Assignment
1	-Strobe	14	Ground
2	-ALF	15	Data 6
3	Data 0	16	Ground
4	-Error	17	Data 7
5	Data 1	18	Ground
6	-Init	19	-ACK
7	Data 2	20	Ground
8	-Scltin	21	Busy
9	Data 3	22	Ground
10	Ground	23	PE
11	Data 4	24	Ground
12	Ground	25	SCLT
13	Data 5	26	Key

CIR1: Consumer IR Connector

This header is for infrared remote control and communication.

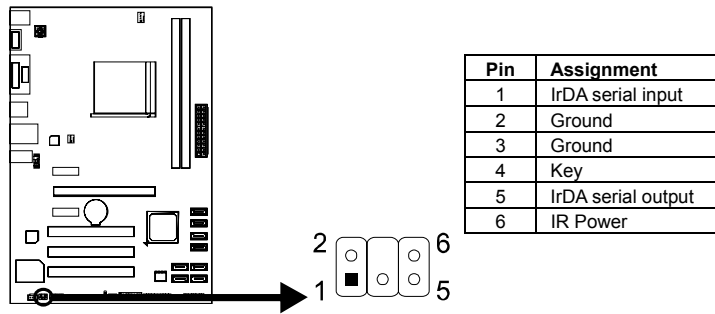

CHAPTER 3: UEFI BIOS & SOFTWARE

3.1 UEFI BIOS Setup

- For better system performance, the UEFI BIOS firmware is being continuously updated. The UEFI BIOS information described below in this manual is for your reference only and the actual UEFI BIOS information and settings on board may be different from this manual
- For further information of setting up the UEFI BIOS, please refer to the UEFI BIOS Manual in the Setup DVD.

3.2 BIOS Update

There are three ways to update the BIOS:
 BIOS Update Utility, BIOS Online Update Utility and BIOS Flasher.

1. BIOS Update Utility

1. Installing BIOS Update Utility from the DVD Driver.
2. Download the proper BIOS from www.biostar.com.tw.

3. Open BIOS Update Utility and click the **Update BIOS** button on the main screen.



4. A warning message will show up to request your agreement to start the BIOS update. Click **OK** to start the update procedure.

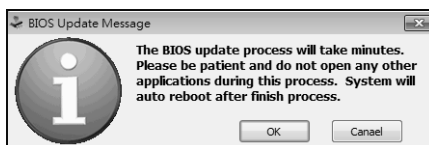

5. Choose the location for your BIOS file in the system. Please select the proper BIOS file, and then click on **Open**. It will take several minutes, please be patient.

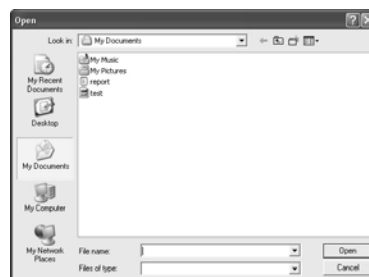

6. After the BIOS Update process is finished, click on **OK** to reboot the system.

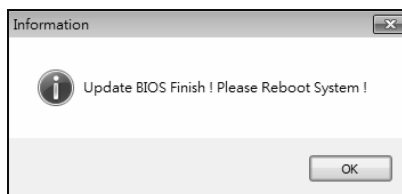

7. While the system boots up and the full screen logo shows up, please press the **Del** <Delete> key to enter BIOS setup.

After entering the BIOS setup, please go to the **Save & Exit**, using the **Restore Defaults** function to load Optimized Defaults, and select **Save Changes and Reset** to restart the computer. Then, the BIOS Update is completed.

Backup BIOS

Click the Backup BIOS button on the main screen for the backup of BIOS, and select a proper location for your backup BIOS file in the system, and click **Save**.

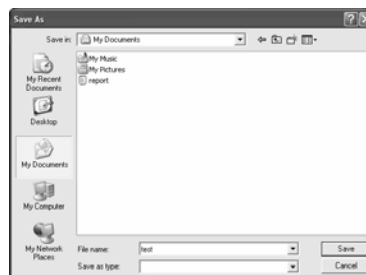

2. Online Update Utility

1. Installing BIOS Update Utility from the DVD Driver.
2. Please make sure the system is connected to the internet before using this function.

3. Open BIOS Update Utility and click the **Online Update** button on the main screen.



4. An open dialog will show up to request your agreement to start the BIOS update. Click **Yes** to start the online update procedure.

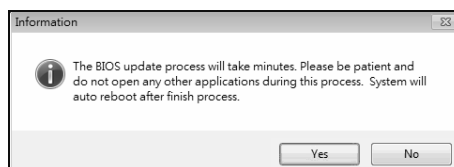

5. If there is a new BIOS version, the utility will ask you to download it. Click **Yes** to proceed.

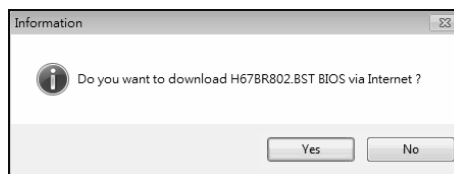

6. After the download is completed, you will be asked to program (update) the BIOS or not. Click **Yes** to proceed.

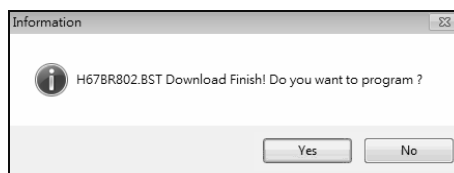

7. After the updating process is finished, you will be asked you to reboot the system. Click **OK** to reboot.

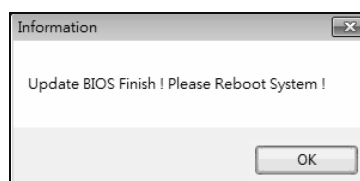

8. While the system boots up and the full screen logo shows up, press  <Delete> key to enter BIOS setup.

After entering the BIOS setup, please go to the **Save & Exit**, using the **Restore Defaults** function to load Optimized Defaults, and select **Save Changes and Reset** to restart the computer. Then, the BIOS Update is completed.

3. BIOSTAR BIOS Flasher

BIOSTAR BIOS Flasher is a BIOS flashing utility providing you an easy and simple way to update your BIOS via USB pen drive.

Note1: This utility only allows storage device with FAT32/16 format and single partition.

Note2: Shutting down or resetting the system while updating the BIOS will lead to system boot failure.

The BIOSTAR BIOS Flasher is built in the BIOS ROM. To enter the utility, **press <F12> during the Power-On Self Tests (POST) procedure** while booting up.

Updating BIOS with BIOSTAR BIOS Flasher

1. Go to the website to download the latest BIOS file for the motherboard.
2. Then, copy and save the BIOS file into a USB flash (pen) drive.
3. Insert the USB pen drive that contains the BIOS file to the USB port.
4. Power on or reset the computer and then press **<F12>** during the **POST** process.

5. After entering the POST screen, the BIOS-FLASHER utility pops out. Choose [fs0] to search for the BIOS file.



6. Select the proper BIOS file, and a message asking if you are sure to flash the BIOS file. Click Yes to start updating BIOS.

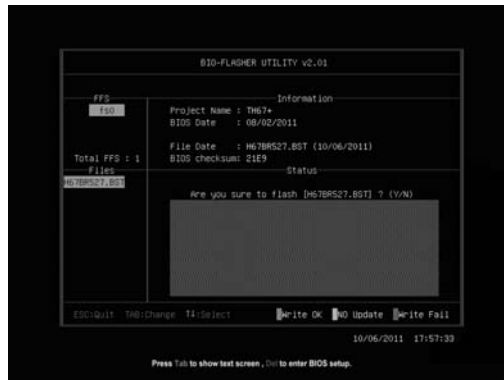

7. A dialog pops out after BIOS flash is completed, asking you to restart the system. Press the [Y] key to restart system.



8. While the system boots up and the full screen logo shows up, press  <Delete> key to enter BIOS setup.

After entering the BIOS setup, please go to the **Save & Exit**, using the **Restore Defaults** function to load Optimized Defaults, and select **Save Changes and Reset** to restart the computer. Then, the BIOS Update is completed.

3.3 Software

Installing Software

1. Insert the Setup DVD to the optical drive. The driver installation program would appear if the Autorun function has been enabled.
2. Select **Software Installation**, and then click on the respective software title.
3. Follow the on-screen instructions to complete the installation.

Note1: All the information and content about following software are subject to be changed without notice. For better performance, the software is being continuously updated.

Note2: The information and pictures described below are for your reference only. The actual information and settings on board may be slightly different from this manual.

Launching Software

After the installation process is completed, you will see the software icon showing on the desktop. Double-click the icon to launch it.

eHot-Line (Optional)

eHot-Line is a convenient utility that helps you to contact with our Tech-Support system. This utility will collect the system information which is useful for analyzing the problem you may have encountered, and then send these information to our tech-support department to help you fix the problem.

Note: Before you use this utility, please set Outlook Express as your default e-mail client application program.

*represents important information that you must provide. Without this information, you may not be able to send out the mail.

This block will show the information which would be collected in the mail.

*Describe condition of your system.

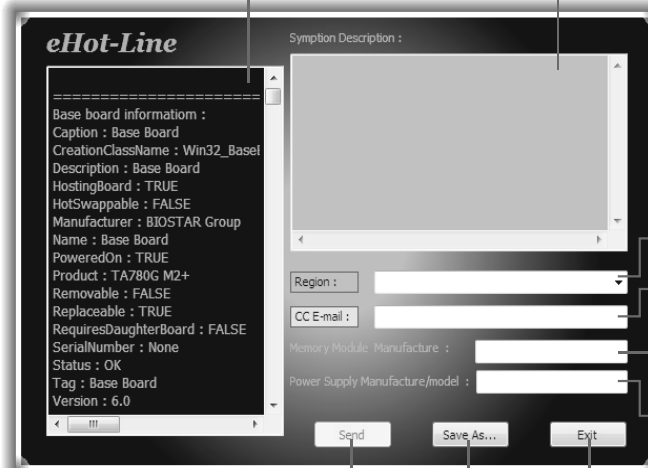

*Select your area or the area close to you.

Provide the e-mail address that you would like to send the copy to.

*Provide the name of the memory module manufacturer.

Provide the name of the power supply manufacturer and the model no.

Send the mail out.

Save these information to a .txt file

Exit this dialog.

After filling up this information, click “Send” to send the mail out. A warning dialog would appear asking for your confirmation; click “Send” to confirm or “Do Not Send” to cancel.



If you want to save this information to a .txt file, click “Save As...” and then you will see a saving dialog appears asking you to enter file name.

Enter the file name and then click “Save”. Your system information will be saved to a .txt file.

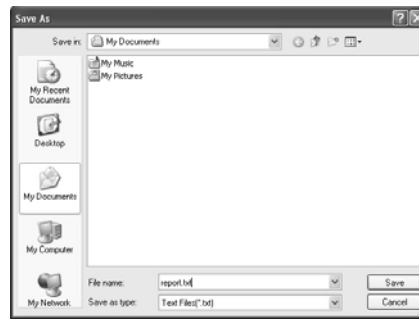

Open the saved .txt file, you will see your system information including motherboard/BIOS/CPU/video/device/OS information. This information is also concluded in the sent mail.



Note1: We will not share customer’s data with any other third parties, so please feel free to provide your system information while using eHot-Line service.

Note2: If you are not using Outlook Express as your default e-mail client application, you may need to save the system information to a .txt file and send the file to our tech support with other e-mail application. Go to the following web <http://www.biostar.com.tw/app/en/about/contact.php> for getting our contact information.

Smart EAR

Smart EAR is a windows-based audio utility which allows you to easily adjust system volume. With its user-friendly GUI, you can also adjust impedance setting (Low/High Gain) to optimize your headphone performance.

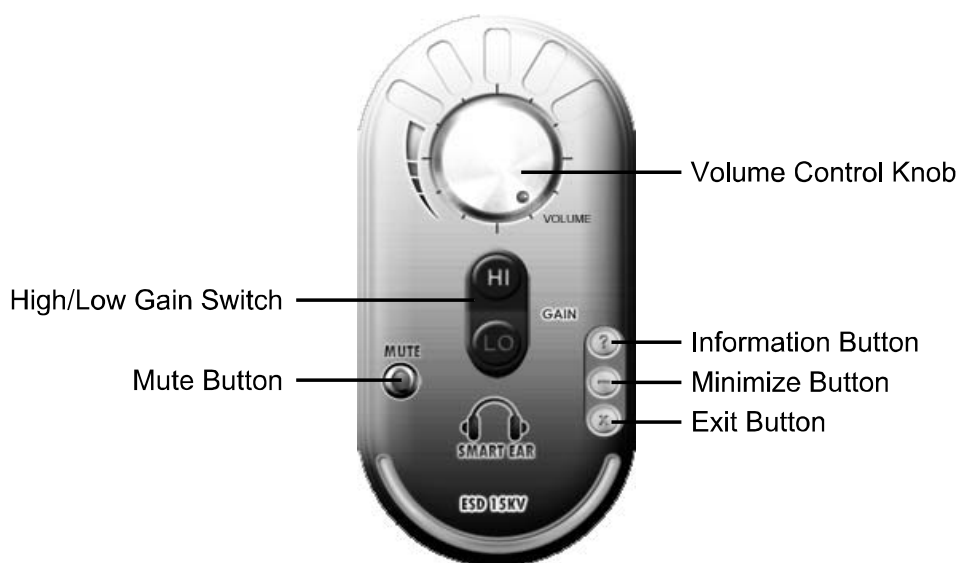

- **High/Low Gain Switch:** Keep the gain switch to low for low impedance headphone and set to high for high impedance headphone.
- **Mute Button:** To disable system sound
- **Volume Control Knob:** The volume can be finely adjusted by turning the knob either clockwise or anti-clockwise to increase or decrease system volume accordingly.
- **Information Button:** Get information of the application
- **Minimize Button:** Minimize the application window to the taskbar
- **Exit Button:** Exit the application

Note:

1. Smart EAR is only supported by Windows 7/8 and BIOSTAR Hi-Fi series motherboards.
2. High/Low Gain Switch is only for "Front Panel Audio Header", please make sure you are connecting your headphone to the front panel I/O.

CHAPTER 4: USEFUL HELP

4.1 Driver Installation

After you installed your operating system, please insert the Fully Setup Driver DVD into your optical drive and install the driver for better system performance.

You will see the following window after you insert the DVD



The setup guide will auto detect your motherboard and operating system.

Note: If this window didn't show up after you insert the Driver DVD, please use file browser to locate and execute the file SETUP.EXE under your optical drive.

A. Driver Installation

To install the driver, please click on the Driver icon. The setup guide will list the compatible driver for your motherboard and operating system. Click on each device driver to launch the installation program.

B. Software Installation

To install the software, please click on the Software icon. The setup guide will list the software available for your system, click on each software title to launch the installation program.

C. Manual

Aside from the paperback manual, we also provide manual in the Driver DVD. Click on the Manual icon to browse for available manual.

Note: You will need Acrobat Reader to open the manual file. Please download the latest version of Acrobat Reader software from <http://get.adobe.com/reader/>

4.2 AMI BIOS Beep Code

Boot Block Beep Codes

Number of Beeps	Description
Continuing	Memory sizing error or Memory module not found

POST BIOS Beep Codes

Number of Beeps	Description
1	Success booting.
8	Display memory error (system video adapter)

4.3 Troubleshooting

Probable	Solution
<ol style="list-style-type: none"> There is no power in the system. Power LED does not shine; the fan of the power supply does not work Indicator light on keyboard does not shine. 	<ol style="list-style-type: none"> Make sure power cable is securely plugged in. Replace cable. Contact technical support.
System is inoperative. Keyboard lights are on, power indicator lights are lit, and hard drives are running.	Using even pressure on both ends of the DIMM, press down firmly until the module snaps into place.
System does not boot from a hard disk drive, but can be booted from optical drive.	<ol style="list-style-type: none"> Check cable running from disk to disk controller board. Make sure both ends are securely plugged in; check the drive type in the standard CMOS setup. Backing up the hard drive is extremely important. All hard disks are capable of breaking down at any time.
System only boots from an optical drive. Hard disks can be read, applications can be used, but system fails to boot from a hard disk.	<ol style="list-style-type: none"> Back up data and applications files. Reformat the hard drive. Re-install applications and data using backup disks.
Screen message shows "Invalid Configuration" or "CMOS Failure."	Review system's equipment. Make sure correct information is in setup.
System cannot boot after user installs a second hard drive.	<ol style="list-style-type: none"> Set master/slave jumpers correctly. Run SETUP program and select correct drive types. Call the drive manufacturers for compatibility with other drives.

CPU Overheated

If the system shutdown automatically after power on system for seconds, that means the CPU protection function has been activated.

When the CPU is over heated, the motherboard will shutdown automatically to avoid a damage of the CPU, and the system may not power on again.

In this case, please double check:

1. The CPU cooler surface is placed evenly with the CPU surface.
2. CPU fan is rotated normally.
3. CPU fan speed is fulfilling with the CPU speed.

After confirmed, please follow steps below to relief the CPU protection function.

1. Remove the power cord from power supply for seconds.
2. Wait for seconds.
3. Plug in the power cord and boot up the system.

Or you can:

1. Clear the CMOS data.
(See "Close CMOS Header: JCMOS1" section)
2. Wait for seconds.
3. Power on the system again.

4.4 RAID Functions

Operating System

Supports Windows Vista , Windows 7 and Windows 8.

Raid Arrays

RAID supports the following types of RAID arrays:

RAID 0: RAID 0 defines a disk striping scheme that improves disk read and write times for many applications.

RAID 1: RAID 1 defines techniques for mirroring data.

RAID 10: RAID 10 combines the techniques used in RAID 0 and RAID 1.

RAID 5: RAID 5 provides fault tolerance and better utilization of disk capacity.

RAID Definitions

RAID 0:

The controller “stripes” data across multiple drives in a RAID 0 array system. It breaks up a large file into smaller blocks and performs disk reads and writes across multiple drives in parallel. The size of each block is determined by the stripe size parameter, which you set during the creation of the RAID set based on the system environment. This technique reduces overall disk access time and offers high bandwidth.

Features and Benefits

- **Drives:** Minimum 2, and maximum is up to 6 or 8. Depending on the platform.
- **Uses:** Intended for non-critical data requiring high data throughput, or any environment that does not require fault tolerance.
- **Benefits:** provides increased data throughput, especially for large files. No capacity loss penalty for parity.
- **Drawbacks:** Does not deliver any fault tolerance. If any drive in the array fails, all data is lost.
- **Fault Tolerance:** No.
- **Total Capacity:** (Minimal. HDD Capacity) x (Connected HDDs Amount)

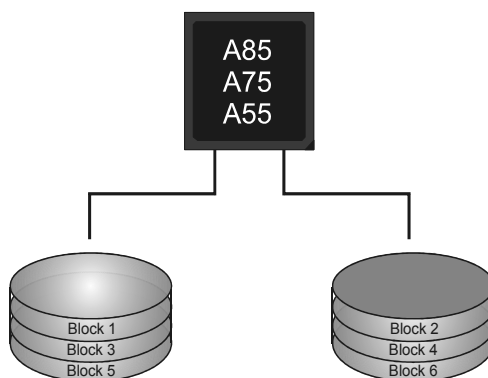

RAID 1:

Every read and write is actually carried out in parallel across 2 disk drives in a RAID 1 array system. The mirrored (backup) copy of the data can reside on the same disk or on a second redundant drive in the array. RAID 1 provides a hot-standby copy of data if the active volume or drive is corrupted or becomes unavailable because of a hardware failure.

RAID techniques can be applied for high-availability solutions, or as a form of automatic backup that eliminates tedious manual backups to more expensive and less reliable media.

Features and Benefits

- **Drives:** Minimum 2, and maximum is 2.
- **Uses:** RAID 1 is ideal for small databases or any other application that requires fault tolerance and minimal capacity.
- **Benefits:** Provides 100% data redundancy. Should one drive fail, the controller switches to the other drive.
- **Drawbacks:** Requires 2 drives for the storage space of one drive. Performance is impaired during drive rebuilds.
- **Fault Tolerance:** Yes.

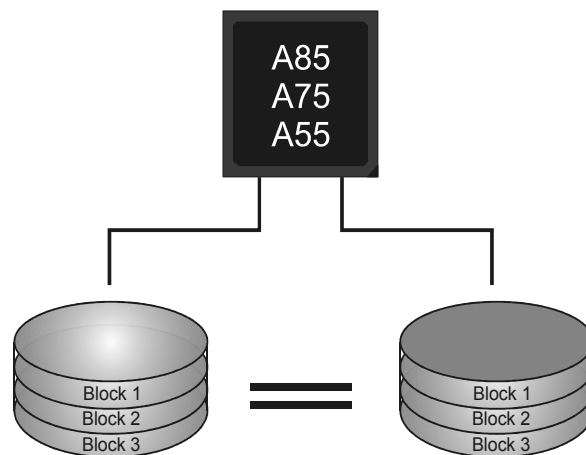

RAID 10:

RAID 1 drives can be striped using RAID 0 techniques. Resulting in a RAID 10 solution for improved resiliency, performance and rebuild performance.

Features and Benefits

- **Drives:** Minimum 4, and maximum is 6 or 8, depending on the platform.
- **Benefits:** Optimizes for both fault tolerance and performance, allowing for automatic redundancy. May be simultaneously used with other RAID levels in an array, and allows for spare disks.
- **Drawbacks:** Requires twice the available disk space for data redundancy, the same as RAID level 1.
- **Fault Tolerance:** Yes.

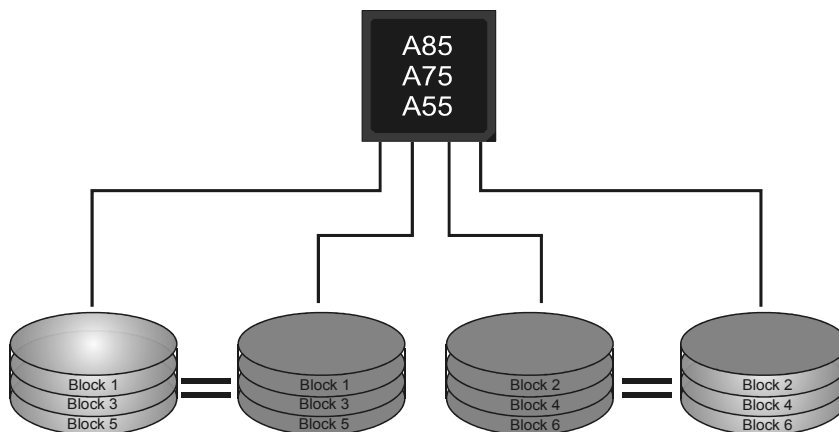

RAID 5:

RAID 5 stripes both data and parity information across three or more drives. It writes data and parity blocks across all the drives in the array. Fault tolerance is maintained by ensuring that the parity information for any given block of data is placed on a different drive from those used to store the data itself.

Note: The RAID 5 function is supported by A85 chipset only.

Features and Benefits

- **Drives:** Minimum 3.
- **Uses:** RAID 5 is recommended for transaction processing and general purpose service.
- **Benefits:** An ideal combination of good performance, good fault tolerance, and high capacity and storage efficiency.
- **Drawbacks:** Individual block data transfer rate same as a single disk. Write performance can be CPU intensive.
- **Fault Tolerance:** Yes.

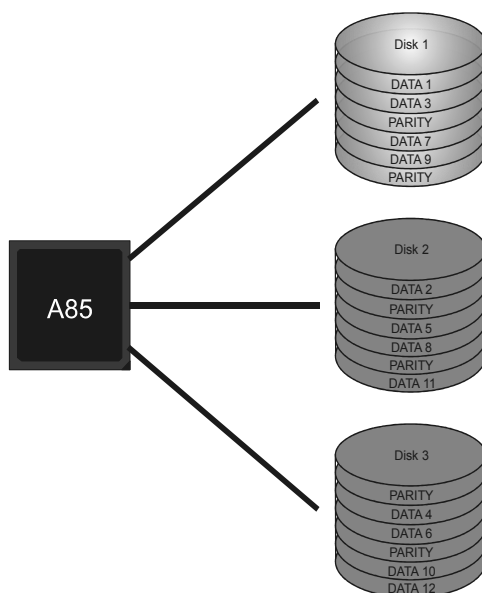

4.5 AMD Dual Graphics Technology

AMD Dual Graphics Technology Introduction

When user adds a PCIE display adapter, it can be integrated with IGD to show better performance. To make the two video devices work simultaneously and normally, please refer to the following setting.

AMD Dual Graphics Requirement

- Operating System: Windows Vista / Windows 7 / Windows 8
- Supported Dual Graphics Combinations:

AMD Radeon™ Graphics Card	A10-Series HD 7660D	A8-Series HD7560D	A6-Series HD 7540D
HD 6670	●	●	
HD 6570	●	●	●
HD 6450			●
● Recommended graphics cards for AMD dual-graphics			

Note 1: A4-Series products do not support Dual Graphics.

Note 2: The information described above in this manual is for your reference only and the actual information and settings on board may be different from this manual. For further AMD Dual Graphics information, please visit the following website: <http://www.amd.com>

AMD Dual Graphics Setup

Step 1: Insert Dual Graphics-Ready graphics card into PEX16_1 slot.

Step 2: Set the BIOS setting as follows:
 [Chipset]→[North Bridge]→[GFX Configuration]
 →[Surround View]→[Enabled]

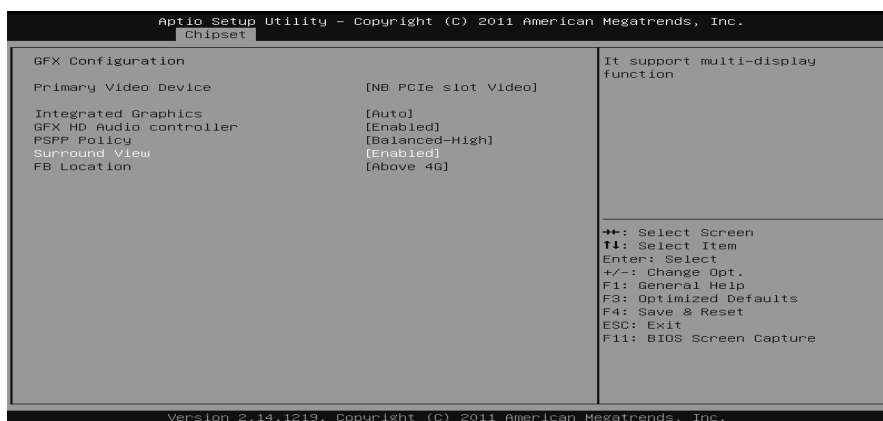

Step 3: Install Driver DVD Chipset Driver, and reboot the system. Activate AMD VISION Engine Control Center to make sure CrossFire has been enabled.

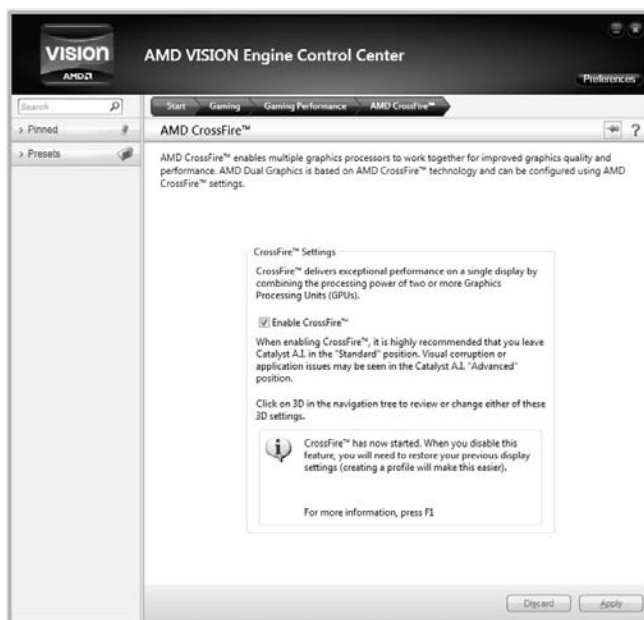

APPENDIX: Specifications In Other Languages**Arabic**

المواصفات		
المأخذ FM 2 لمعالج ايه إم دي AMD تسلسل A الحد الأقصى للطاقة الحرارية في تصميم المعالج (thermal design power – TDP): 100 واط. * يرجى الرجوع إلى الموقع www.biostar.com.tw لقائمة دعم المعالج CPU.	قاعدة وحدة المعالجة المركزية	
AMD A85 FCH (Hi-Fi A85S2) AMD A75 FCH (Hi-Fi A75S2) AMD A55 FCH (Hi-Fi A55S2)	مجموعة الشرائح	
تدعم قناة مزدوجة دي. دي. ار. DDR3 / 1066 / 1333 / 1600 / 1866 x2 دي. دي. ار. DDR3 فتحات الذاكرة المزدوجة DIMM، تتحمل كحد أقصى 32 جيجابايت ذاكرة كل فتحة مزدوجة DIMM تتحمل دون ECC 512 ميجا بايت / 16/8/4/2/1 جيجابايت دي. دي. ار. DDR3 * يرجى الرجوع إلى الموقع www.biostar.com.tw لقائمة دعم الذاكرة.	الذاكرة	
ايه إم دي AMD FCH A85/A75/A55 تتحمّل رايد RAID 5 / 0 / 1 / 10 / AHCI (FCH A85) تتحمّل رايد RAID 0 / 1 / 10 / AHCI (FCH A75/A55)	التخزين	
ريالتيك رت ل REALTEK RTL 8111F 10 / 100 / 1000 ميجابايت / الثانية ، تحديد تلقائي ، النصف / القدرة القصوى المزدوجة	شبكة محلية LAN	
ALC892 5.1 قنوات عالية الدقة، Biostar Hi-Fi	الترميز الصوتي	
يه إم دي AMD A85/A75 FCH منافذ x 6 ناقل متسلسل عام USB 2.0 (2 في المداخل والمخارج الخلفية و 4 من خلال الموزع الداخلي) منافذ x 4 ناقل متسلسل عام USB 3.0 (2 في المداخل والمخارج الخلفية و 2 من خلال الموزع الداخلي) يه إم دي AMD A55 FCH منافذ x 8 ناقل متسلسل عام USB 2.0 (4 في المداخل والمخارج الخلفية و 4 من خلال الموزع الداخلي)	ناقل متسلسل عام USB	
3 x فتحة منفذ الملحقات الإضافية PCI 2 x فتحة منفذ الملحقات الإضافية PCIe x2.0 1 x فتحة منفذ الملحقات الإضافية PCIe x2.0 16	فتحات التوسع	
Hi-Fi A55S2 1 x PS/2 الفأرة 1 x PS/2 لوحة المفاتيح للكمبيوتر فتحة توصيل عدد 1 x منظومة العرض المرئي VGA فتحة توصيل عدد 1 x واجهة مرئية رقمية DVI فتحة لتوصيل عدد 1 x الشبكة المحلية LAN فتحة توصيل عدد 4 x ناقل متسلسل عام USB 2.0 فتحة توصيل عدد 3 x جاك للصوت	Hi-Fi A85S2/ Hi-Fi A75S2 1 x PS/2 الفأرة 1 x PS/2 لوحة المفاتيح للكمبيوتر فتحة توصيل عدد 1 x HDMI وبسيط متعدد العلي الوضوح فتحة توصيل عدد 1 x منظومة العرض المرئي VGA فتحة توصيل عدد 1 x واجهة مرئية رقمية DVI فتحة لتوصيل عدد 1 x الشبكة المحلية LAN فتحة توصيل عدد 2 x ناقل متسلسل عام USB 2.0 فتحة توصيل عدد 2 x ناقل متسلسل عام USB 3.0 فتحة توصيل عدد 3 x جاك للصوت	المداخل والمخارج الخلفية

Hi-Fi A85S2/Hi-Fi A75S2/Hi-Fi A55S2

المواصفات			
Hi-Fi A55S2	Hi-Fi A75S2	Hi-Fi A85S2	
وصلة 6 SATA x 3 جيجابايت / الثانية	وصلة 6 SATA x 6 جيجابايت / الثانية	وصلة 8 SATA x 6 جيجابايت / الثانية	المدخل والمخارج الداخلية
موزع x2 ناقل متصل عام	موزع x2 ناقل متصل عام	موزع x2 ناقل متصل عام	
2.0 USB	2.0 USB	2.0 USB	
موصلة للطاقة 1 x 4 دبابيس	موزع x1 ناقل متصل عام	موزع x1 ناقل متصل عام	
وصلة للطاقة 1 x 24 دبوس	3.0 USB	3.0 USB	
وصلة x 1 مروحة تبريد وحدة المعالجة المركزية	موصلة للطاقة 1 x 4 دبابيس	موصلة للطاقة 1 x 4 دبابيس	
وصلة x2 مراوح تبريد المنظومة	وصلة للطاقة 1 x 24 دبوس	وصلة للطاقة 1 x 24 دبوس	
موزع x 1 اللوحة الأمامية	وصلة x 1 مروحة تبريد وحدة المعالجة المركزية	وصلة x 1 مروحة تبريد وحدة المعالجة المركزية	
موزع x1 الصوت الأمامي	وصلة x2 مراوح تبريد المنظومة	وصلة x2 مراوح تبريد المنظومة	
موزع x1 سيموس مباشر	موزع x 1 اللوحة الأمامية	موزع x 1 اللوحة الأمامية	
موزع x1 فتحة للطابعة	موزع x1 الصوت الأمامي	موزع x1 الصوت الأمامي	
موزع 1 x مستهلك IR	موزع x1 سيموس مباشر	موزع x1 سيموس مباشر	
موزع 1 x فتحة تسلسلية	موزع x1 فتحة للطابعة	موزع x1 فتحة للطابعة	
وصلة 1 x خارجية S/PDIF	موزع 1 x مستهلك IR	موزع 1 x مستهلك IR	
سوني فيليبس الواجهة الرقمية	موزع 1 x فتحة تسلسلية	موزع 1 x فتحة تسلسلية	
	وصلة 1 x خارجية S/PDIF	وصلة 1 x خارجية S/PDIF	
	سوني فيليبس الواجهة الرقمية	سوني فيليبس الواجهة الرقمية	
عامل شكل مدد التكنولوجيا المتقدمة ATX • 295 مم x 200 مم			عامل الشكل
ويندوز إكس بي windows xp / ويندوز فيستا / ويندوز 7 / ويندوز 8			أنظمة التشغيل المدعومة
بيوستار BIOSTAR تحتفظ بحق إضافة أو إزالة الدعم لأي نظام تشغيل مع أو بدون أنظار.			

French

Spécifications																															
Support Unité Centrale	Interface de connexion FM2 pour série A AMD processeur Enveloppe thermique Unité Centrale maximum : 100Watt * Veuillez vous reporter à www.biostar.com.tw pour la liste des supports modèles d'Unité Centrale.																														
Jeu de puces	AMD A85 FCH (Hi-Fi A85S2) AMD A75 FCH (Hi-Fi A75S2) AMD A55 FCH (Hi-Fi A55S2)																														
Mémoire	Supporte mémoire DDR3 double canal 800/ 1066/ 1333/ 1600/ 1866 Banc de mémoire 2 x DDR3 DIMM, Supporte max. jusqu'à une mémoire de 32 GB Chaque module DIMM supporte module DDR3 non-ECC 512MB/ 1/ 2/ 4/ 8/ 16 GB * Veuillez vous reporter à www.biostar.com.tw pour la liste des soutien de la mémoire.																														
Stockage	AMD A85/A75/A55 FCH Supporte système RAID 0,1,10, 5 & AHCI (A85 FCH) Supporte système RAID 0,1,10 & AHCI (A75/A55 FCH)																														
Réseau local	Realtek RTL 8111F 10/ 100/ 1000 Mb/s auto négociation, capacité bidirectionnelle à l'alternat / bidirectionnelle simultanée																														
Codec audio	ALC892 Canaux 5.1, écoute audio de haute définition, Biostar Hi-Fi																														
USB	AMD A85/A75 FCH Port 6x USB 2.0 (2 sur les I/O arrières et 4 en interne) Port 4x USB 3.0 (2 sur les I/O arrières et 2 en interne) AMD A55 FCH Port 8x USB 2.0 (4 sur les I/O arrières et 4 en interne)																														
Connecteur d'extension	3x Fente PCI 2x PCIe 2.0 x1 Fente 1x PCIe 2.0 x16 Fente																														
I/O arrières	<table style="width: 100%; border-collapse: collapse;"> <thead> <tr> <th style="width: 33%; text-align: left;">Hi-Fi A85S2:</th> <th style="width: 33%; text-align: left;">Hi-Fi A75S2:</th> <th style="width: 33%; text-align: left;">Hi-Fi A55S2:</th> </tr> </thead> <tbody> <tr> <td>1x PS/2 Clavier</td> <td>1x PS/2 Clavier</td> <td>1x PS/2 Clavier</td> </tr> <tr> <td>1x PS/2 Souris</td> <td>1x PS/2 Souris</td> <td>1x PS/2 Souris</td> </tr> <tr> <td>1x Port HDMI</td> <td>1x Port HDMI</td> <td>1x Port VGA</td> </tr> <tr> <td>1x Port VGA</td> <td>1x Port VGA</td> <td>1x Port DVI</td> </tr> <tr> <td>1x Port DVI</td> <td>1x Port DVI</td> <td>1x port LAN</td> </tr> <tr> <td>1x port LAN</td> <td>1x port LAN</td> <td>4x Port USB 2.0</td> </tr> <tr> <td>2x Port USB 2.0</td> <td>2x Port USB 2.0</td> <td>3x entrées audio</td> </tr> <tr> <td>2x Port USB 3.0</td> <td>2x Port USB 3.0</td> <td></td> </tr> <tr> <td>3x entrées audio</td> <td>3x entrées audio</td> <td></td> </tr> </tbody> </table>	Hi-Fi A85S2:	Hi-Fi A75S2:	Hi-Fi A55S2:	1x PS/2 Clavier	1x PS/2 Clavier	1x PS/2 Clavier	1x PS/2 Souris	1x PS/2 Souris	1x PS/2 Souris	1x Port HDMI	1x Port HDMI	1x Port VGA	1x Port VGA	1x Port VGA	1x Port DVI	1x Port DVI	1x Port DVI	1x port LAN	1x port LAN	1x port LAN	4x Port USB 2.0	2x Port USB 2.0	2x Port USB 2.0	3x entrées audio	2x Port USB 3.0	2x Port USB 3.0		3x entrées audio	3x entrées audio	
Hi-Fi A85S2:	Hi-Fi A75S2:	Hi-Fi A55S2:																													
1x PS/2 Clavier	1x PS/2 Clavier	1x PS/2 Clavier																													
1x PS/2 Souris	1x PS/2 Souris	1x PS/2 Souris																													
1x Port HDMI	1x Port HDMI	1x Port VGA																													
1x Port VGA	1x Port VGA	1x Port DVI																													
1x Port DVI	1x Port DVI	1x port LAN																													
1x port LAN	1x port LAN	4x Port USB 2.0																													
2x Port USB 2.0	2x Port USB 2.0	3x entrées audio																													
2x Port USB 3.0	2x Port USB 3.0																														
3x entrées audio	3x entrées audio																														

Hi-Fi A85S2/Hi-Fi A75S2/Hi-Fi A55S2

Spécifications			
	Hi-Fi A85S2:	Hi-Fi A75S2:	Hi-Fi A55S2:
	8x Connecteur SATA 6.0Gb/s	6x Connecteur SATA 6.0Gb/s	6x Connecteur SATA 3.0Gb/s
	2x embases USB 2.0	2x embases USB 2.0	2x embases USB 2.0
	1x embases USB 3.0	1x embases USB 3.0	1x 4-Broche de carte
	1x 4-Broche de carte	1x 4-Broche de carte	1x 24-Broche de carte
	1x 24-Broche de carte	1x 24-Broche de carte	1x Connecteur ventilateur unité centrale
	1x Connecteur ventilateur unité centrale	1x Connecteur ventilateur unité centrale	2x Connecteur ventilateur système
	2x Connecteur ventilateur système	2x Connecteur ventilateur système	1x Fiche panneau avant
	1x Fiche panneau avant	1x Fiche panneau avant	1x Fiche audio avant
	1x Fiche audio avant	1x Fiche audio avant	1x Fiche mémoire CMOS vide
	1x Fiche mémoire CMOS vide	1x Fiche mémoire CMOS vide	1x Embase port imprimante
	1x Embase port imprimante	1x Embase port imprimante	1x Fiche Registre d'état
	1x Fiche Registre d'état	1x Fiche Registre d'état	Consommateur
	Consommateur	Consommateur	1x Embase port série
	1x Embase port série	1x Embase port série	1x Connecteur sortie S/PDIF
	1x Connecteur sortie S/PDIF	1x Connecteur sortie S/PDIF	
Facteur d'encombrement	Facteur d'encombrement ATX, 295 mm x 200 mm		
Support SE	Windows XP / Vista / 7 / 8 Biostar se réserve le droit d'ajouter ou d'enlever le support pour toute SE avec ou sans préavis.		

German

Spezifikationen																															
CPU-Unterstützung	Anschluss-FM2 für AMD A-Serie Prozessor Maximale CPU TDP (Thermal Design Power): 100 Watt * Bitte konsultieren Sie www.biostar.com.tw für CPU-Unterstützungsliste																														
Chipset	AMD A85 FCH (Hi-Fi A85S2) AMD A75 FCH (Hi-Fi A75S2) AMD A55 FCH (Hi-Fi A55S2)																														
Festplattenspeicher	Unterstützt zweikanaliges DDR3 800/ 1066/ 1333/ 1600/ 1866 2 x DDR3 DIMM-SpeicherSlot, Max. Unterstützung bis zu 32 GB-Speicher Jedes DIMM unterstützt nicht-ECC 512MB/ 1/ 2/ 4/ 8/ 16 GB DDR3-Module * Bitte konsultieren Sie www.biostar.com.tw für Speicherunterstützung Liste.																														
Arbeitsspeicher	AMD A85/A75/A55 FCH Unterstützt RAID 0,1,10, 5 & AHCI (A85 FCH) Unterstützt RAID 0,1,10 & AHCI (A75/A55 FCH)																														
LAN	Realtek RTL 8111F 10/ 100/ 1000 Mb Auto-Negotiation, Halb- / Voll-Duplex-fähig																														
Audio-Codec	ALC892 5.1 Kanäle, HD-Audio, Biostar Hi-Fi																														
USB	AMD A85/A75 FCH: 6x USB 2.0-Port (2 hintere I/Os und 4 via interne Header) 4x USB 3.0-Port (2 hintere I/Os und 2 via interne Header) AMD A55 FCH: 8x USB 2.0-Port (4 hintere I/Os und 4 via interne Header)																														
Erweiterungsschlüsse	3x PCI-Slot 2x PCIe 2.0 x1-Slot 1x PCIe 2.0 x16-Slot																														
Hintere I/Os	<table border="0"> <thead> <tr> <th>Hi-Fi A85S2:</th> <th>Hi-Fi A75S2:</th> <th>Hi-Fi A55S2:</th> </tr> </thead> <tbody> <tr> <td>1x PS/2-Maus</td> <td>1x PS/2-Maus</td> <td>1x PS/2-Maus</td> </tr> <tr> <td>1x PS/2-Keyboard</td> <td>1x PS/2-Keyboard</td> <td>1x PS/2-Keyboard</td> </tr> <tr> <td>1x HDMI-Port</td> <td>1x HDMI-Port</td> <td>1x VGA-Port</td> </tr> <tr> <td>1x VGA-Port</td> <td>1x VGA-Port</td> <td>1x DVI-Port</td> </tr> <tr> <td>1x DVI-Port</td> <td>1x DVI-Port</td> <td>1x LAN-Port</td> </tr> <tr> <td>1x LAN-Port</td> <td>1x LAN-Port</td> <td>4x USB 2.0-Port</td> </tr> <tr> <td>2x USB 2.0-Port</td> <td>2x USB 2.0-Port</td> <td>3x Audio Jack</td> </tr> <tr> <td>2x USB 3.0-Port</td> <td>2x USB 3.0-Port</td> <td></td> </tr> <tr> <td>3x Audio Jack</td> <td>3x Audio Jack</td> <td></td> </tr> </tbody> </table>	Hi-Fi A85S2:	Hi-Fi A75S2:	Hi-Fi A55S2:	1x PS/2-Maus	1x PS/2-Maus	1x PS/2-Maus	1x PS/2-Keyboard	1x PS/2-Keyboard	1x PS/2-Keyboard	1x HDMI-Port	1x HDMI-Port	1x VGA-Port	1x VGA-Port	1x VGA-Port	1x DVI-Port	1x DVI-Port	1x DVI-Port	1x LAN-Port	1x LAN-Port	1x LAN-Port	4x USB 2.0-Port	2x USB 2.0-Port	2x USB 2.0-Port	3x Audio Jack	2x USB 3.0-Port	2x USB 3.0-Port		3x Audio Jack	3x Audio Jack	
Hi-Fi A85S2:	Hi-Fi A75S2:	Hi-Fi A55S2:																													
1x PS/2-Maus	1x PS/2-Maus	1x PS/2-Maus																													
1x PS/2-Keyboard	1x PS/2-Keyboard	1x PS/2-Keyboard																													
1x HDMI-Port	1x HDMI-Port	1x VGA-Port																													
1x VGA-Port	1x VGA-Port	1x DVI-Port																													
1x DVI-Port	1x DVI-Port	1x LAN-Port																													
1x LAN-Port	1x LAN-Port	4x USB 2.0-Port																													
2x USB 2.0-Port	2x USB 2.0-Port	3x Audio Jack																													
2x USB 3.0-Port	2x USB 3.0-Port																														
3x Audio Jack	3x Audio Jack																														

Hi-Fi A85S2/Hi-Fi A75S2/Hi-Fi A55S2

Spezifikationen			
	Hi-Fi A85S2:	Hi-Fi A75S2:	Hi-Fi A55S2:
Interne I/Os	8x SATA 6.0Gb/s-Verbindung	6x SATA 6.0Gb/s-Verbindung	6x SATA 3.0Gb/s-Verbindung
	2x USB 2.0-Header	2x USB 2.0-Header	2x USB 2.0-Header
	1x USB 3.0-Header	1x USB 3.0-Header	1x 4-Pin-Stromverbindung
	1x 4-Pin-Stromverbindung	1x 4-Pin-Stromverbindung	1x 24-Pin-Stromverbindung
	1x 24-Pin-Stromverbindung	1x 24-Pin-Stromverbindung	1x CPU-Ventilatorverbindung
	1x CPU-Ventilatorverbindung	1x CPU-Ventilatorverbindung	2x System-Ventilatorverbindung
	2x System-Ventilatorverbindung	2x System-Ventilatorverbindung	1x Header für Frontpanel
	1x Header für Frontpanel	1x Header für Frontpanel	1x Header für Frontaudio
	1x Header für Frontaudio	1x Header für Frontaudio	1x Header für klares CMOS
	1x Header für klares CMOS	1x Header für klares CMOS	1x Header für Druckerport
	1x Header für Druckerport	1x Header für Druckerport	1x Consumer IR-Header
	1x Consumer IR-Header	1x Consumer IR-Header	1x Serieller Port-Header
	1x Serieller Port-Header	1x Serieller Port-Header	1x S/PDI-
	1x S/PDI-	1x S/PDI-	Auswurfsverbindung
	Auswurfsverbindung	Auswurfsverbindung	
Formfaktor	ATX Formfaktor, 295 mm x 200 mm		
OS-Unterstützung	Windows XP / Vista / 7 / 8 Biostar reserves the right to add or remove support for any OS with or without notice.		

Italian

Specificazioni			
Supporto processore	Slot FM2 per processore AMD serie-A Alimentazione di Proiezione Termico (TDP – Thermal Design Power): 100Watt * Si prega di consultare www.biostar.com.tw per la lista di supporto del processore.		
Tipo scheda	AMD A85 FCH (Hi-Fi A85S2) AMD A75 FCH (Hi-Fi A75S2) AMD A55 FCH (Hi-Fi A55S2)		
Memoria	Supporta DDR3 800/ 1066/ 1333/ 1600/ 1866 Doppio Canale 2 x DDR3 DIMM Slot di Memoria Supporta fino a 32 GB Memoria Ogni DIMM supporta non-ECC 512MB/ 1/ 2/ 4/ 8/ 16 GB DDR3 moduli * Si prega di consultare www.biostar.com.tw per la lista di supporto del memoria.		
Memorizzazione	AMD A85/A75/A55 FCH Supporta RAID 0,1,10, 5 & AHCI (A85 FCH) Supporta RAID 0,1,10 & AHCI (A75/A55 FCH)		
Catena	Realtek RTL 8111F 10/ 100/ 1000 Mb auto negoziazione, capacita di duplex Meta / Completo		
Codec Audio	ALC892 Canali Audio di Alta Definizione 5.1, Biostar Hi-Fi		
USB	Piattaforma AMD A85/A75 FCH: Slot 6x USB 2.0 (2 nei ingressi/ uscite posteriore e 4 da distributori interni) Slot 4x USB 3.0 (2 nei ingressi/ uscite posteriore e 2 da distributori interni) Piattaforma AMD A55 FCH: Slot 8x USB 2.0 (4 nei ingressi/ uscite posteriore e 4 da distributori interni)		
Slot di espansione	Slot 3x PCI Slot 2x PCIe 2.0 x1 Slot 1x PCIe 2.0 x16		
Ingressi/ Uscite Posteriore	Hi-Fi A85S2: Mouse 1x PS/2 Tastiera 1x PS/2 Slot 1x HDMI Slot 1x VGA Slot 1x DVI Slot 1x LAN Slot 2x USB 2.0 Slot 2x USB 3.0 Jack audio 3x	Hi-Fi A75S2: Mouse 1x PS/2 Tastiera 1x PS/2 Slot 1x HDMI Slot 1x VGA Slot 1x DVI Slot 1x LAN Slot 2x USB 2.0 Slot 2x USB 3.0 Jack audio 3x	Hi-Fi A55S2: Mouse 1x PS/2 Tastiera 1x PS/2 Slot 1x VGA Slot 1x DVI Slot 1x LAN Slot 4x USB 2.0 Jack audio 3x

Hi-Fi A85S2/Hi-Fi A75S2/Hi-Fi A55S2

Specificazioni				
	Hi-Fi A85S2:	Hi-Fi A75S2:	Hi-Fi A55S2:	
Ingressi/ Uscite Interni	Connettore 8x SATA 6.0Gb/s	Connettore 6x SATA 6.0Gb/s	Connettore 6x SATA 3.0Gb/s	
	Distributore 2x USB 2.0	Distributore 2x USB 2.0	Distributore 2x USB 2.0	
	Distributore 1x USB 3.0	Distributore 1x USB 3.0	Connettore con 4 pin x1	
	Connettore con 4 pin x1	Connettore con 4 pin x1	Connettore con 24 pin x1	
	Connettore con 24 pin x1	Connettore con 24 pin x1	Connettore Ventilatore processore x1	
	Connettore Ventilatore processore x1	Connettore Ventilatore processore x1	Connettore Ventilatore Sistema x2	
	Connettore Ventilatore Sistema x2	Connettore Ventilatore Sistema x2	Distributore Pannello Frontale x1	
	Distributore Pannello Frontale x1	Distributore Pannello Frontale x1	Distributore Audio Frontale x1	
	Distributore Audio Frontale x1	Distributore Audio Frontale x1	Distributore CMOS Diretto x1	
	Distributore CMOS Diretto x1	Distributore CMOS Diretto x1	Distributore Slot Stampante x1	
	Distributore Slot Stampante x1	Distributore Slot Stampante x1	Distributore Consumabile IR x1	
	Distributore Consumabile IR x1	Distributore Consumabile IR x1	Distributore Slot Serie x1	
	Distributore Slot Serie x1	Distributore Slot Serie x1	Connettore esterno S/PDIF x1	
	Connettore esterno S/PDIF x1	Connettore esterno S/PDIF x1		
	Fattore di Forma	Fattore di Forma ATX, 295 mm x 200 mm		
	Supporto SO	Windows XP / Vista / 7 / 8 Biostar si riserva il diritto di aggiungere o ritirare il supporto per qualsiasi SO con o senza preavviso.		

Japanese

仕様			
CPU サポート	AMD A-シリーズ プロセッサの Socket FM2 最大 CPU TDP (Thermal Design Power 最大放熱量) :100 W *CPU サポート リストについては、 www.biostar.com.tw を参照してください。		
チップセット	AMD A85 FCH (Hi-Fi A85S2) AMD A75 FCH (Hi-Fi A75S2) AMD A55 FCH (Hi-Fi A55S2)		
メモリ	デュアルチャンネル DDR3 800/ 1066/ 1333/ 1600/ 1866 をサポート 2 x DDR3 DIMM メモリ スロット、最大 32 GB メモリまでサポート 各 DIMM は、非-ECC 512MB/ 1/ 2/ 4/ 8/ 16 GB DDR3 モジュールをサポートしています *サポートされているメモリのリストについては、 www.biostar.com.tw を参照してください。		
保存スペース	AMD A85/A75/A55 FCH RAID 0,1,10, 5 & AHCI のサポート (A85 FCH) RAID 0,1,10 & AHCI のサポート (A75/A55 FCH)		
LAN	Realtek RTL 8111F 10/ 100/ 1000 Mb/s オートネゴシエーション、半/全 二重通信		
オーディオ コーデック	ALC892 5.1 チャンネル、ハイ デフィニション オーディオ、Biostar Hi-Fi		
USB	AMD A85/A75 FCH: 6x USB 2.0 ポート (後部 I/O に2つ 及び 内蔵ヘッダー経由に4つ) 4x USB 3.0 ポート (後部 I/O に2つ 及び 内蔵ヘッダー経由に2つ) AMD A55 FCH: 8x USB 2.0 ポート (後部 I/O に4つ 及び 内蔵ヘッダー経由に4つ)		
拡張スロット	3x PCI スロット 2x PCIe 2.0 x1 スロット 1x PCIe 2.0 x16 スロット		
後部 I/O	Hi-Fi A85S2: 1x PS/2 キーボード 1x PS/2 マウス 1x HDMI ポート 1x VGA ポート 1x DVI ポート 1x LAN ポート 2x USB 2.0 ポート 2x USB 3.0 ポート 3x オーディオ ジャック	Hi-Fi A75S2: 1x PS/2 キーボード 1x PS/2 マウス 1x HDMI ポート 1x VGA ポート 1x DVI ポート 1x LAN ポート 2x USB 2.0 ポート 2x USB 3.0 ポート 3x オーディオ ジャック	Hi-Fi A55S2: 1x PS/2 キーボード 1x PS/2 マウス 1x VGA ポート 1x DVI ポート 1x LAN ポート 4x USB 2.0 ポート 3x オーディオ ジャック

Hi-Fi A85S2/Hi-Fi A75S2/Hi-Fi A55S2

仕様			
	Hi-Fi A85S2:	Hi-Fi A75S2:	Hi-Fi A55S2:
内蔵 I/O	8x SATA 6.0Gb/s コネクタ	6x SATA 6.0Gb/s コネクタ	6x SATA 3.0Gb/s コネクタ
	2x USB 2.0 ヘッダー	2x USB 2.0 ヘッダー	2x USB 2.0 ヘッダー
	1x USB 3.0 ヘッダー	1x USB 3.0 ヘッダー	1x 4-Pin パワー コネクタ
	1x 4-Pin パワー コネクタ	1x 4-Pin パワー コネクタ	1x 24-Pin パワー コネクタ
	1x 24-Pin パワー コネクタ	1x 24-Pin パワー コネクタ	1x CPU ファン コネクタ
	1x CPU ファン コネクタ	1x CPU ファン コネクタ	2x システム ファン コネクタ
	2x システム ファン コネクタ	2x システム ファン コネクタ	1x フロント パネル ヘッダー
	1x フロント パネル ヘッダー	1x フロント パネル ヘッダー	1x フロント オーディオ ヘッダー
	1x フロント オーディオ ヘッダー	1x フロント オーディオ ヘッダー	1x クリア CMOS ヘッダー
	1x クリア CMOS ヘッダー	1x クリア CMOS ヘッダー	1x プリンター ポート ヘッダー
	1x プリンター ポート ヘッダー	1x プリンター ポート ヘッダー	—
	1x コンシューマー IR ヘッダー	1x コンシューマー IR ヘッダー	1x コンシューマー IR ヘッダー
	1x シリアル ポート ヘッダー	1x シリアル ポート ヘッダー	1x シリアル ポート ヘッダー
	1x S/PDIF アウト コネクタ	1x S/PDIF アウト コネクタ	1x S/PDIF アウト コネクタ
フォーム ファクタ	ATX フォーム ファクタ、295 mm x 200 mm		
サポート OS	Windows XP / Vista / 7 / 8 Biostar には、通知なしでサポート OS を変更する権限があります。		

Polish

Specyfikacje techniczne			
Obsługa procesora	Gniazdo procesora (Socket) FM2 dla procesorów AMD seria-A Moc Wydzielanego Ciepła (TDP - Thermal Design Power): 100Watt * Proszę sprawdzić listę obsługiwanych procesorów na stronie internetowej www.biostar.com.tw		
Rodzaj płyty	AMD A85 FCH (Hi-Fi A85S2) AMD A75 FCH (Hi-Fi A75S2) AMD A55 FCH (Hi-Fi A55S2)		
Pamięć	Obsługa pamięci DDR3 800/ 1066/ 1333/ 1600/ 1866 Dwukanałowa 2 x DDR3 DIMM Pamięć Gniazda procesora (Slot), Maksymalna wielkość pamięci 32 GB Każdy DIMM obsługuje jeden moduł non-ECC 512MB/ 1/ 2/ 4/ 8/ 16 GB DDR3 * Proszę sprawdzić listę obsługiwanych pamięć na stronie internetowej www.biostar.com.tw		
Przechowywanie	AMD A85/A75 FCH Obsługa RAID 0,1,10, 5 & AHCI (A85 FCH) Obsługa RAID 0,1,10 & AHCI (A75/A55 FCH)		
LAN	Układ RTL 8111F 10/ 100/ 1000 Mb auto negocjacja, pojemność duplex Połowe / Pełny		
Codec Audio	ALC892 Kanały Audio wysokiej Definicji 5.1, Biostar Hi-Fi		
USB	Płyta AMD A85/A75 FCH: 6 x złącza USB 2.0 (2 przez tylne porty wejścia/ wyjścia oraz 4 przez wewnętrzne porty) 4 x złącza USB 3.0 (2 przez tylne porty wejścia/ wyjścia oraz 2 przez wewnętrzne porty) Płyta AMD A55 FCH: 8 x złącza USB 2.0 (4 przez tylne porty wejścia/ wyjścia oraz 4 przez wewnętrzne porty)		
Złącza rozszerzeń	złącza 3x PCI (Slot) złącza 2x PCIe 2.0 x1 (Slot) złącza 1x PCIe 2.0 x16 (Slot)		
Tylne porty wejścia/ wyjścia	Hi-Fi A85S2: Myszka 1x PS/2 Klawiatura 1x PS/2 Port 1x HDMI (gniazdo) Port 1x VGA Port 1x DVI Port 1x LAN Porty 2x USB 2.0 Porty 2x USB 3.0 Porty audio 3x	Hi-Fi A75S2: Myszka 1x PS/2 Klawiatura 1x PS/2 Port 1x HDMI (gniazdo) Port 1x VGA Port 1x DVI Port 1x LAN Porty 2x USB 2.0 Porty 2x USB 3.0 Porty audio 3x	Hi-Fi A55S2: Myszka 1x PS/2 Klawiatura 1x PS/2 Port 1x VGA Port 1x DVI Port 1x LAN Porty 4x USB 2.0 Porty audio 3x

Specyfikacje techniczne			
	Hi-Fi A85S2:	Hi-Fi A75S2:	Hi-Fi A55S2:
Wewnętrzne porty wejścia/ wyjścia	Złącza 8x SATA 6.0Gb/s	Złącza 6x SATA 6.0Gb/s	Złącza 6x SATA3.0Gb/s
	Złącza 2x USB 2.0	Złącza 2x USB 2.0	Złącza 2x USB 2.0
	Złącza 1x USB 3.0	Złącza 1x USB 3.0	Złącza 4 pionowe x 1
	Złącza 4 pionowe x 1	Złącza 4 pionowe x 1	Złącza 24 pionowe x 1
	Złącza 24 pionowe x 1	Złącza 24 pionowe x 1	Złącze wentylatora CPU x 1
	Złącze wentylatora CPU x 1	Złącze wentylatora CPU x 1	Złącze wentylatora obudowy x 2
	Złącze wentylatora obudowy x 2	Złącze wentylatora obudowy x 2	Złącze przedniego panelu x1
	Złącze przedniego panelu x1	Złącze przedniego panelu x1	Złącze audio przedniego panelu x1
	Złącze audio przedniego panelu x1	Złącze audio przedniego panelu x1	Złącze bezpośrednie CMOS x1
	Złącze bezpośrednie CMOS x1	Złącze bezpośrednie CMOS x1	Złącze port drukarki x1
	Złącze port drukarki x1	Złącze port drukarki x1	Złącze konsument IR x1
	Złącze konsument IR x1	Złącze konsument IR x1	Port szeregowy x1
	Port szeregowy x1	Port szeregowy x1	Port zewnętrzny S/PDIF x1
	Port zewnętrzny S/PDIF x1	Port zewnętrzny S/PDIF x1	
Obudowa	Obudowa ATX, 295 mm x 200 mm		
Obsługa OS	Windows XP / Vista / 7 / 8 Biostar zastrzega sobie prawo do dodania lub wycofania obsługi dla OS, z wypowiedzeniem lub bez wypowiedzenia.		

Portuguese

Especificações			
Suporte Processador	Porta FM2 para processador AMD série-A Alimentação de Design Térmico (TDP – Thermal Design Power): 100Watt * Por favor consulte www.biostar.com.tw para obter uma lista de suporte do processador.		
Tipo Placa Mãe	AMD A85 FCH (Hi-Fi A85S2) AMD A75 FCH (Hi-Fi A75S2) AMD A55 FCH (Hi-Fi A55S2)		
Memória	Suporta DDR3 800/ 1066/ 1333/ 1600/ 1866 Canal Duplo 2 x DDR3 DIMM Slot de memória Suporta até 32 GB Memória Cada DIMM suporta non-ECC 512MB/ 1/ 2/ 4/ 8/ 16 GB DDR3 módulo * Por favor consulte www.biostar.com.tw para obter uma lista de suporte do memória.		
Armazenamento	AMD A85/A75/A55 FCH Suporta RAID 0,1,10, 5 & AHCI (A85 FCH) Suporta RAID 0,1,10 & AHCI (A75/A55 FCH)		
LAN	Realtek RTL 8111F 10/ 100/ 1000 Mb auto negociação, capacidade duplex Metade / Cheio		
Codec de Audio	ALC892 Canais de Áudio de Alta Definição 5.1, Biostar Hi-Fi		
USB	Plataforma AMD A85/A75 FCH: Porta 6x USB 2.0 (2 nas entradas/saídas traseiras e 4 pelos Dispositivos internos) Porta 4x USB 3.0 (2 nas entradas/saídas traseiras e 2 pelos Dispositivos internos) Plataforma AMD A55 FCH: Porta 8x USB 2.0 (4 nas entradas/saídas traseiras e 4 pelos Dispositivos internos)		
Slots de expansão	Porta 3x PCI Porta 2x PCIe 2.0 x1 Porta 1x PCIe 2.0 x16		
Entradas/Saídas no painel traseiro	Hi-Fi A85S2: Mouse 1x PS/2 Teclado 1x PS/2 Porta 1x HDMI Porta 1x VGA Porta 1x DVI Porta 1x LAN Porta 2x USB 2.0 Porta 2x USB 3.0 Soquete audio 3x	Hi-Fi A75S2: Mouse 1x PS/2 Teclado 1x PS/2 Porta 1x HDMI Porta 1x VGA Porta 1x DVI Porta 1x LAN Porta 2x USB 2.0 Porta 2x USB 3.0 Soquete audio 3x	Hi-Fi A55S2: Mouse 1x PS/2 Teclado 1x PS/2 Porta 1x VGA Porta 1x DVI Porta 1x LAN Porta 4x USB 2.0 Soquete audio 3x

Especificações			
	Hi-Fi A85S2:	Hi-Fi A75S2:	Hi-Fi A55S2:
Conectores na placa	Conector 8x SATA 6.0Gb/s	Conector 6x SATA 6.0Gb/s	Conector 6x SATA 3.0Gb/s
	Dispositivo 2x USB 2.0	Dispositivo 2x USB 2.0	Dispositivo 2x USB 2.0
	Dispositivo 1x USB 3.0	Dispositivo 1x USB 3.0	Conector de 4 pinos x1
	Conector de 4 pinos x1	Conector de 4 pinos x1	Conector de 24 pinos x1
	Conector de 24 pinos x1	Conector de 24 pinos x1	Conector de Ventoinha processador x1
	Conector de Ventoinha processador x1	Conector de Ventoinha processador x1	Conector de Ventoinha Sistema x2
	Conector de Ventoinha Sistema x2	Conector de Ventoinha Sistema x2	Dispositivo Painel Frontal x1
	Dispositivo Painel Frontal x1	Dispositivo Painel Frontal x1	Dispositivo de Audio Frontal x1
	Dispositivo de Audio Frontal x1	Dispositivo de Audio Frontal x1	Dispositivo CMOS Direct x1
	Dispositivo CMOS Direct x1	Dispositivo CMOS Direct x1	Dispositivo Porta Impressora x1
	Dispositivo Porta Impressora x1	Dispositivo Porta Impressora x1	Dispositivo Porta Impressora x1
	Dispositivo Porta Impressora x1	Dispositivo Porta Impressora x1	Dispositivo Porta Série x1
	Dispositivo Porta Série x1	Dispositivo Porta Série x1	Conector Externo S/PDIF x1
	Conector Externo S/PDIF x1	Conector Externo S/PDIF x1	
Fator de Fôrma	Fator de Fôrma ATX, 295 mm x 200 mm		
Suporte OS	Windows XP / Vista / 7 / 8 Biostar reserva seu direito de adicionar ou retirar o suporte para qualquer OS com ou sem notificação.		

Russian

Спецификации																															
Поддержка центрального процессора	Сокет FM2 для процессоров AMD серии A Максимальный термопакет центрального процессора (TDP): 100 ватт * Перечень поддержки центрального процессора смотрите на www.biostar.com.tw .																														
Набор микросхем	AMD A85 FCH (Hi-Fi A85S2) AMD A75 FCH (Hi-Fi A75S2) AMD A55 FCH (Hi-Fi A55S2)																														
Память	Поддерживает двухканальный DDR3 800/ 1066/ 1333/ 1600/ 1866 2 гнезда платы памяти DDR3 DIMM, максимальная память до 32 Гб Каждый модуль DIMM поддерживает модуль не-ECC 512 Мб/ 1/ 2/ 4/ 8/ 16 Гб DDR3 * Перечень поддержки памяти смотрите на www.biostar.com.tw .																														
Накопитель	AMD A85/A75/A55 FCH Поддерживает RAID 0,1,10, 5 & AHCI (A85 FCH) Поддерживает RAID 0,1,10 & AHCI (A75/A55 FCH)																														
Локальная сеть	Realtek RTL 8111F Автосогласование 10/ 100/ 1000 Мб/с, работает в полно/полудуплексном режиме																														
Аудиокодек	ALC892 Каналы 5.1, высококачественное аудио, Biostar Hi-Fi																														
USB	AMD A85/A75 FCH: 6 портов USB 2.0 (2 сзади ввода-вывода и 4 через внутренние контакты) 4 портов USB 3.0 (2 сзади ввода-вывода и 2 через внутренние контакты) AMD A55 FCH: 8 портов USB 2.0 (4 сзади ввода-вывода и 4 через внутренние контакты)																														
Гнезда расшир.	3x гнезда PCI 2x PCIe 2.0 x1 гнездо 1x PCIe 2.0 x16 гнездо																														
Задняя плата ввода-вывода	<table border="0"> <thead> <tr> <th>Hi-Fi A85S2:</th> <th>Hi-Fi A75S2:</th> <th>Hi-Fi A55S2:</th> </tr> </thead> <tbody> <tr> <td>1 мышь PS/2</td> <td>1 мышь PS/2</td> <td>1 мышь PS/2</td> </tr> <tr> <td>1 клавиатура PS/2</td> <td>1 клавиатура PS/2</td> <td>1 клавиатура PS/2</td> </tr> <tr> <td>1 порт HDMI</td> <td>1 порт HDMI</td> <td>1 порт VGA</td> </tr> <tr> <td>1 порт VGA</td> <td>1 порт VGA</td> <td>1 порт DVI</td> </tr> <tr> <td>1 порт DVI</td> <td>1 порт DVI</td> <td>1 порт локальной сети</td> </tr> <tr> <td>1 порт локальной сети</td> <td>1 порт локальной сети</td> <td>4 порта USB 2.0</td> </tr> <tr> <td>2 порта USB 2.0</td> <td>2 порта USB 2.0</td> <td>3 гнезд для подключения наушников</td> </tr> <tr> <td>2 порта USB 3.0</td> <td>2 порта USB 3.0</td> <td></td> </tr> <tr> <td>3 гнезд для подключения наушников</td> <td>3 гнезд для подключения наушников</td> <td></td> </tr> </tbody> </table>	Hi-Fi A85S2:	Hi-Fi A75S2:	Hi-Fi A55S2:	1 мышь PS/2	1 мышь PS/2	1 мышь PS/2	1 клавиатура PS/2	1 клавиатура PS/2	1 клавиатура PS/2	1 порт HDMI	1 порт HDMI	1 порт VGA	1 порт VGA	1 порт VGA	1 порт DVI	1 порт DVI	1 порт DVI	1 порт локальной сети	1 порт локальной сети	1 порт локальной сети	4 порта USB 2.0	2 порта USB 2.0	2 порта USB 2.0	3 гнезд для подключения наушников	2 порта USB 3.0	2 порта USB 3.0		3 гнезд для подключения наушников	3 гнезд для подключения наушников	
Hi-Fi A85S2:	Hi-Fi A75S2:	Hi-Fi A55S2:																													
1 мышь PS/2	1 мышь PS/2	1 мышь PS/2																													
1 клавиатура PS/2	1 клавиатура PS/2	1 клавиатура PS/2																													
1 порт HDMI	1 порт HDMI	1 порт VGA																													
1 порт VGA	1 порт VGA	1 порт DVI																													
1 порт DVI	1 порт DVI	1 порт локальной сети																													
1 порт локальной сети	1 порт локальной сети	4 порта USB 2.0																													
2 порта USB 2.0	2 порта USB 2.0	3 гнезд для подключения наушников																													
2 порта USB 3.0	2 порта USB 3.0																														
3 гнезд для подключения наушников	3 гнезд для подключения наушников																														

Hi-Fi A85S2/Hi-Fi A75S2/Hi-Fi A55S2

Спецификации				
	Hi-Fi A85S2:	Hi-Fi A75S2:	Hi-Fi A55S2:	
Внутр. Плата ввода-вывода	Соединитель 8x SATA 6 Гб/с	Соединитель 6x SATA 6 Гб/с	Соединитель 6x SATA 3 Гб/с	
	2 контакта USB 2.0	2 контакта USB 2.0	2 контакта USB 2.0	
	1 контакта USB 3.0	1 контакта USB 3.0	1 4-выводный разъем питания	
	1 4-выводный разъем питания	1 4-выводный разъем питания	1 24-выводный разъем питания	
	1 24-выводный разъем питания	1 24-выводный разъем питания	1 разъем вентилятора ЦП	
	1 разъем вентилятора ЦП	1 разъем вентилятора ЦП	2 разъема вентилятора системы	
	2 разъема вентилятора системы	2 разъема вентилятора системы	1 контакт передней панели	
	1 контакт передней панели	1 контакт передней панели	1 контакт передней аудиопанели	
	1 контакт передней аудиопанели	1 контакт передней аудиопанели	1 контакт микросхемы Clear CMOS	
	1 контакт микросхемы Clear CMOS	1 контакт микросхемы Clear CMOS	1 контакт порта принтера	
	1 контакт порта принтера	1 контакт порта принтера	1 инфракрасный пользовательский контакт	
	1 инфракрасный пользовательский контакт	1 инфракрасный пользовательский контакт	1 контакт последовательного порта	
	1 контакт последовательного порта	1 контакт последовательного порта	1 соединитель S/PDIF-Out	
	1 соединитель S/PDIF-Out	1 соединитель S/PDIF-Out		
	Конструктив	Форм-фактор ATX, 295 мм x 200 мм		
	Поддержка ОС	Windows XP / Vista / 7 / 8 Biostar оставляет за собой право добавлять или удалять поддержку любой ОС, с уведомлением или без.		

Spanish

Especificaciones																															
Compatibilidad con el procesador	Ranura FM2 para procesador AMD serie - A Alimentación de Proyección Térmica (TDP – Thermal Design Power): 100Watt *Por favor consultar con www.biostar.com.tw para la lista de compatibilidad con el procesador.																														
Tipo de Placa	AMD A85 FCH (Hi-Fi A85S2) AMD A75 FCH (Hi-Fi A75S2) AMD A55 FCH (Hi-Fi A55S2)																														
Memoria	Soporta DDR3 800/ 1066/ 1333/ 1600/ 1866 Doble Canal 2x DDR3 DIMM Ranura de memoria Soporta hasta 32 GB Memoria Cada DIMM soporta un modulo non-ECC 512MB/ 1/ 2/ 4/ 8/ 16 GB DDR3 *Por favor consultar con www.biostar.com.tw para la lista de compatibilidad con el memoria.																														
Almacenamiento de información	AMD A85/A75/A55 FCH Soporta RAID 0,1,10, 5 & AHCI (A85 FCH) Soporta RAID 0,1,10 & AHCI (A75/A55 FCH)																														
LAN	Realtek RTL 8111F 10/ 100/ 1000 Mb/s auto negociación, capacidad dúplex Mitad/Completo																														
Códec Audio	ALC892 Canales Audio de Alta Definición 5.1, Biostar Hi-Fi																														
USB	Plataforma AMD A85/A75 FCH: Ranura 6x USB 2.0 (2 en las entradas/salidas posteriores y 4 por los distribuidores internos) Ranura 4x USB 3.0 (2 en las entradas/salidas posteriores y 2 por los distribuidores internos) Plataforma AMD A55 FCH: Ranura 8x USB 2.0 (4 en las entradas/salidas posteriores y 4 por los distribuidores internos)																														
Ranuras de Extinción	Ranura 3x PCI Ranura 2x PCIe 2.0 x1 Ranura 1x PCIe 2.0 x16																														
Panel trasero de E/S	<table border="0"> <thead> <tr> <th>Hi-Fi A85S2:</th> <th>Hi-Fi A75S2:</th> <th>Hi-Fi A55S2:</th> </tr> </thead> <tbody> <tr> <td>Ratón 1x PS/2</td> <td>Ratón 1x PS/2</td> <td>Ratón 1x PS/2</td> </tr> <tr> <td>Teclado 1x PS/2</td> <td>Teclado 1x PS/2</td> <td>Teclado 1x PS/2</td> </tr> <tr> <td>Ranura 1x HDMI</td> <td>Ranura 1x HDMI</td> <td>Ranura 1x VGA</td> </tr> <tr> <td>Ranura 1x VGA</td> <td>Ranura 1x VGA</td> <td>Ranura 1x DVI</td> </tr> <tr> <td>Ranura 1x DVI</td> <td>Ranura 1x DVI</td> <td>Ranura 1x LAN</td> </tr> <tr> <td>Ranura 1x LAN</td> <td>Ranura 1x LAN</td> <td>Ranura 4x USB 2.0</td> </tr> <tr> <td>Ranura 2x USB 2.0</td> <td>Ranura 2x USB 2.0</td> <td>Socket audio 3x</td> </tr> <tr> <td>Ranura 2x USB 3.0</td> <td>Ranura 2x USB 3.0</td> <td></td> </tr> <tr> <td>Socket audio 3x</td> <td>Socket audio 3x</td> <td></td> </tr> </tbody> </table>	Hi-Fi A85S2:	Hi-Fi A75S2:	Hi-Fi A55S2:	Ratón 1x PS/2	Ratón 1x PS/2	Ratón 1x PS/2	Teclado 1x PS/2	Teclado 1x PS/2	Teclado 1x PS/2	Ranura 1x HDMI	Ranura 1x HDMI	Ranura 1x VGA	Ranura 1x VGA	Ranura 1x VGA	Ranura 1x DVI	Ranura 1x DVI	Ranura 1x DVI	Ranura 1x LAN	Ranura 1x LAN	Ranura 1x LAN	Ranura 4x USB 2.0	Ranura 2x USB 2.0	Ranura 2x USB 2.0	Socket audio 3x	Ranura 2x USB 3.0	Ranura 2x USB 3.0		Socket audio 3x	Socket audio 3x	
Hi-Fi A85S2:	Hi-Fi A75S2:	Hi-Fi A55S2:																													
Ratón 1x PS/2	Ratón 1x PS/2	Ratón 1x PS/2																													
Teclado 1x PS/2	Teclado 1x PS/2	Teclado 1x PS/2																													
Ranura 1x HDMI	Ranura 1x HDMI	Ranura 1x VGA																													
Ranura 1x VGA	Ranura 1x VGA	Ranura 1x DVI																													
Ranura 1x DVI	Ranura 1x DVI	Ranura 1x LAN																													
Ranura 1x LAN	Ranura 1x LAN	Ranura 4x USB 2.0																													
Ranura 2x USB 2.0	Ranura 2x USB 2.0	Socket audio 3x																													
Ranura 2x USB 3.0	Ranura 2x USB 3.0																														
Socket audio 3x	Socket audio 3x																														

Especificaciones			
	Hi-Fi A85S2:	Hi-Fi A75S2:	Hi-Fi A55S2:
Conectores en placa	Conector 8x SATA 6Gb's	Conector 6x SATA 6Gb's	Conector 6x SATA 3Gb's
	Distribuidor 2x USB 2.0	Distribuidor 2x USB 2.0	Distribuidor 2x USB 2.0
	Distribuidor 1x USB 3.0	Distribuidor 1x USB 3.0	Conector con 4 patillas x1
	Conector con 4 patillas x1	Conector con 4 patillas x1	Conector con 24 patillas x1
	Conector con 24 patillas x1	Conector con 24 patillas x1	Conector Ventilador procesador x1
	Conector Ventilador procesador x1	Conector Ventilador procesador x1	Conector Ventilador Sistema x2
	Conector Ventilador Sistema x2	Conector Ventilador Sistema x2	Distribuidor Panel Frontal x1
	Distribuidor Panel Frontal x1	Distribuidor Panel Frontal x1	Distribuidor Audio Frontal x1
	Distribuidor Audio Frontal x1	Distribuidor Audio Frontal x1	Distribuidor CMOS Directo x1
	Distribuidor CMOS Directo x1	Distribuidor CMOS Directo x1	Distribuidor Ranura Impresora x1
	Distribuidor Ranura Impresora x1	Distribuidor Ranura Impresora x1	Distribuidor Consumible IR x1
	Distribuidor Consumible IR x1	Distribuidor Consumible IR x1	Distribuidor Ranura Serie x1
	Distribuidor Ranura Serie x1	Distribuidor Ranura Serie x1	Conector Externo S/PDIF x1
	Conector Externo S/PDIF x1	Conector Externo S/PDIF x1	
Factor de Forma	Factor de Forma ATX, 295 mm x 200 mm		
Soporte OS	Windows XP / Vista / 7 / 8 Biostar reserva su derecho de añadir o retirar el soporte para cada OS con o sin notificación.		

2012/12/12